

Aanbeveling / Conseil / Recommendation / Empfehlung

NL

Het is de taak van de DIENST NA VERKOOP te zorgen voor de vervanging van beschadigde stukken:

- hetzij op onze verantwoordelijkheid omdat, ondanks onze beste inspanningen, toch een beschadigd stuk werd geleverd
- hetzij op de verantwoordelijkheid van de klant ten gevolge van een slechte behandeling of door verkeerd onderhoud.

In het kader van de verantwoordelijkheid van de leverancier

De niet-gelijkvormigheid dient te worden vastgesteld en ons door de klant te worden bekendgemaakt binnen de 10 werkdagen volgend op de ontvangst van het bouwpakket.

Aanvragen tot vervanging worden alleen voldaan mits voorlegging van het beschadigd element in de winkel waar het tuinhuis werd aangekocht.

Wanneer de elementen zelf niet kunnen worden aangeboden, is het de klant toegestaan een foto te bezorgen die het probleem duidelijk bewijst.

Reeds gebouwde of verwerkte elementen kunnen niet ten laste worden gelegd van de leverancier. De aanvraag dient daarbij ten allen tijde precies te zijn geformuleerd en in één keer aan ons te zijn gericht door de winkel waar het tuinhuis werd verkocht, met gebruik van het document dat wij daartoe speciaal ter beschikking stellen. Het fabricatienummer dient verplicht te worden vermeld. (PO-n°)

De beschadigde stukken worden gratis geleverd, hetzij thuis bij de klant zelf of bij de winkel.

Indien een 2e aanvraag zou worden geformuleerd worden de vervangstukken automatisch geleverd aan de winkel waar het tuinhuis werd aangekocht. In alle gevallen behoudt de leverancier zich het recht voor om eventueel de gegrondheid van de aanvraag of het gebrek aan bezwarende elementen ten zijnen laste te controleren die zouden bewijzen dat hij verantwoordelijk is voor het vastgestelde probleem.

OPGELET : HET NUMMER DAT BEGINT MET "PO", VERMELD OP DE VERPAKKING, DIENT VERPLICHT TE WORDEN VERMELD BIJ ELKE AANVRAAG GERICHT AAN DE DNV.

ER DIENT REKENING TE WORDEN GEHOUDEN MET HET VOLGENDE :

Hout is een levende materie. Bij droog weer kunnen zich tussen de planken scheuren en spleten vormen die weer verdwijnen bij vochtiger weer.

Bij hout is het niet meer dan normaal dat zich een aantal onregelmatigheden voordoen. Om die reden worden de volgende afwijkingen dan ook beschouwd als aanvaardbaar:

- knoesten in het hout
- knoesten die loskomen van het hout met een maximale doorsnede van 2 cm
- knoesten die zich losmaken van de zaagrand van de planken op voorwaarde dat de zo gevormde gaten bij de montage worden dichtgestopt
- verkleuring (schaadt nergens de levensduur van het hout)
- rechte scheuren en spleten indien het geen wijd openstaande spleten betreft en deze de plank niet doorsnijden
- scheuren en spleten op de uiteinden van de planken als het gaat om spleten die niet langer zijn dan de breedte van de liggers of van de planken
- droogte- of krimpspleten die de stevigheid van de constructie niet in het gedrang brengen
- het verschijnen van hars over een maximale lengte van 5 cm
- verdraaiing (torsie) en kromtrekking als de montage er niet door gehinderd wordt.

Bij droog weer is het mogelijk dat zich knoesten losmaken. De zo gevormde gaten dienen te worden dichtgestopt met houtpasta.

F

Le SERVICE APRES VENTE est destiné à remplacer les pièces défectueuses

- du fait du fournisseur dans le cas ou malgré toute notre attention une pièce défectueuse aurait été livrée.
- du fait du client par suite de mauvaise manipulation ou par défaut d'entretien.

Dans le cadre de la responsabilité du fournisseur

La non-conformité doit être constatée et signalée par le client dans les 10 jours ouvrés suivant la réception par lui du colis.

Toute demande ne pourra être satisfaite qu'après présentation de la pièce défectueuse au magasin ou l'abri a été acheté. A défaut, une photo permettant de se rendre compte du problème pourra être acceptée.

Les pièces déjà montées ou modifiées ne font pas l'objet d'un SAV à la charge du fournisseur. La demande doit être précise, elle doit être rédigée en une seule fois, par le magasin qui a vendu l'abri, à l'aide du document remis à cet effet. Le numéro de fabrication (PO-n°) doit obligatoirement y figurer.

Les pièces défectueuses seront livrées gratuitement au domicile du client ou au magasin. Si une 2ème demande devait être formulée, les pièces seraient alors automatiquement livrées au magasin ou l'abri a été acheté. Dans tous les cas, le fournisseur se réserve la possibilité d'apprécier le bien fondé de la demande ou l'absence d'éléments prouvant que le problème constaté lui est imputable.

ATTENTION : LE NUMERO COMMENCANT PAR "PO" FIGURANT SUR L'EMBALLAGE DOIT OBLIGATOIREMENT ETRE COMMUNIQUE POUR TOUTE DEMANDE DE SAV .



LES NOTIONS SUIVANTES SONT A PRENDRE EN COMPTE :

Le bois vit, par temps sec des felles peuvent apparaître entre les planches, elles disparaissent par temps humide. Il est normal que certaines anomalies puissent apparaître dans le bois, ainsi, les anomalies suivantes sont considérées comme tolérables :

- Nœuds dans le bois
- Nœuds se détachant du bois ayant un diamètre maximum de 2 cm
- Nœuds se détachant de la tranche des planches à condition que lors de l'assemblage le trou soit recouvert
- Décoloration (ne nuit pas à la durée de vie du bois)
- Fentes droites, si celles-ci ne sont pas ouvertes et ne traversent pas la planche
- Fentes aux extrémités si elles ne sont pas plus longues que la largeur des poutres ou des planches
- Fentes de séchage ou rétrécissement qui ne nuisent pas à la construction
- Apparition de résine sur une longueur maximum de 5cm
- Torsion et gauchissement si l'assemblage n'en est pas gêné

Par temps sec, des nœuds peuvent se détacher, il faut boucher les trous avec de la pâte à bois

GB

It is the job of the AFTER SALES DEPARTMENT to see to the due replacement of faulty sections:

- either under the responsibility of the supplier when, in spite of our best efforts, faulty or non-compliant sections have been supplied
- or under the responsibility of the customer due to faulty handling or through inappropriate maintenance.

Under the responsibility of the supplier

Non-conformity is to be established by the customer, duly notifying us within 10 working days following receipt of the kit. Applications will only be met upon presentation of the faulty section at the shop where the garden shed was purchased.

If the sections are unavailable to be presented, the customer is allowed to provide photographic evidence, clearly showing the problem.

Sections already mounted or assembled and subsequently found to be faulty or non-compliant cannot be imputed to the supplier. At all times, applications are required to be accurately stated and to have been compiled in a single effort by the shop where the garden shed was sold, using the purpose-provided document. In doing so, it is compulsory for the manufacturing number (PO-n°) to be listed.

Any replacement sections will be supplied free of charge, either directly to the customer's home address or to the shop. If a second application should be submitted, the replacement sections will be delivered directly to the shop where the garden shed was sold.

In all cases, the supplier reserves the right, should he so wish, to verify the legitimacy of any applications, or the lack of elements at his charge which would serve to corroborate that he is liable for the problem as found.

PLEASE NOTE : IT IS COMPULSORY FOR THE REFERENCE NUMBER STARTING WITH "PO", AS SHOWN ON THE PACKAGE, TO BE LISTED IN ANY APPLICATION ADDRESSED TO THE ASD.

DUE ACCOUNT MUST BE TAKEN OF THE FOLLOWING :

Wood is a living, breathing material. In dry weather conditions, cracks and tears may appear in the planks which vanish when weather conditions become more damp. Certain perceived "flaws" are perfectly normal in wood. Which is why the following series of non-conformities are wholly acceptable as falling within industry-accepted tolerance margins:

- knots in the wood
- knots standing proud from the wood surface with a maximum 2 cm cross-section
- knots standing proud from the sawing edge of the planks provided that the resulting holes are filled upon assembly using wood filler
- discolouration or fading (does not detract from the wood's life span)
- straight tears and cracks, provided these are not wide open cracks transecting the plank
- tears and cracks at the far tips of the planks, provided the cracks do not exceed the width of the girders or the planks
- cracks and tears as a result of shrinkage or desiccation, which do not jeopardise the solidity of the construction
- the appearance of resin over a maximum 5 cm length
- torsioning and warping, provided this does nothing to impede assembly.

In dry weather conditions, it is possible for knots to stand proud. Any holes thus formed are to be filled using wood filler.

D

Holzschutz für unbehandelte Nadelhölzer im Außenbereich beraten und beachten Sie die Verarbeitungshinweise des Farbenherstellers. Wiederholungsanstriche sollten je nach Abwitterung vorgenommen werden. Durch einen ausreichenden Holzschutz beeinflussen Sie im wesentlichen die Lebensdauer Ihres Gartenhauses.

Holzqualität /Reklamation

Das von Ihnen gekaufte Produkt ist aus bestem Fichtenholz hergestellt. Holz ist ein Naturprodukt und jedes Holzteil hat eine eigene Farbgebung und arbeitet unterschiedlich. Holz sieht nie gleich aus, daß macht dieses Material so beliebt. Wenn es trotz unserer sorgfältigen Werkskontrolle zu Reklamationen kommen sollte, geben Sie Ihrem Fachhändler folgende Unterlagen und Informationen:

- Kontrollnummer (PO-n°)Welche Bauteile reklamiert werden (Pos.Nr und Anzahl)
- Reklamationsgrund, ggf. durch Bilder ergänzen
- Lieferanschrift für die Ersatzteillieferung
- Ihre Telefonnummer, für evtl. Rückfragen

Ansprüche auf Gewährleistung beschränken sich auf den Austausch von fehlerhaftem Material. Alle weiteren Ansprüche sind ausgeschlossen! Bereits verarbeitetes Material ist vom Umtausch ausgeschlossen!

Abweichungen die keinen Reklamationsgrund darstellen :

- Äste die mit dem Holz fest verwachsen sind.
- Holzverfärbungen, ohne das dadurch die Lebensdauer beeinflusst wird.
- Risse /Trockenrisse die nicht durchgehend sind und nicht die Konstruktion beeinflussen.
- Längsverleimte (Keilverzinkung) Bretter sind an-teilmäßig erlaubt und liegen in der Norm
- Verdrehungen des Holzes vorausgesetzt es läßt sich noch verarbeiten.
- An den nicht sichtbaren Seiten von Dach- und Fußbodenbrettern können die Bretter ungehobelt sein bzw. Baumkante enthalten.

Bereits verbaute oder gestrichene Bauteile sind von der Reklamation ausgeschlossen. Für Reklamationen, bei denen ein schlechtes Fundament, ein fehlerhafter Anstrich oder aber ein Montagefehler der Grund für auftretende Probleme sind, müssen wir die anfallenden Kundendienstkosten in Rechnung stellen. Die Reklamierte Bauteile müssen bis zum Abschluss der Reklamation aufbewahrt werden. Wir behalten uns das Recht vor, die Reklamation beim Kunden zu prüfen.

Bedachung/Dachrinnen : Bedachungsmaterial/Dachrinnensysteme gehören nicht zum werkseitigen Lieferumfang, lassen Sie sich hier bei Ihrem Fachhändler beraten. Beim Verlegen bzw. bei der Montage beachten Sie bitte die Herstellerhinweise. Windsicherung: Das Produkt muss nach der Montage zusätzlich gegen Wind gesichert werden. Versicherung: Sprechen Sie mit Ihrem Versicherungsfachmann, ob durch Ihre bestehenden Versicherungen, ein voller Versicherungsschutz für das Produkt besteht.

Im Falle einer Uneinigkeit nach dem Verkauf, die nicht mit dem normalen Verfahren gelöst werden konnte, kann Solid eine Person zur Baustelle schicken. Sollte sich aus diesem Besuch auf der Baustelle ergeben, das das Produkt nicht mangelhaft ist, so behält Solid das Recht, für den Transport 250 € excl. MwSt zu berechnen und ist Solid keinesfalls für eventuelle Minderwerte zuständig

Aanbeveling / Conseil / Recommendation / Empfehlung

NL

TERMIJNEN :

De leverancier stelt alles in het werk om de vervangementen zo snel mogelijk te leveren. Niettemin rust wat dit betreft op de leverancier geen enkele verplichting inzake levertijden.

AANSPRAKELIJKHEID :

De aansprakelijkheid van de leverancier is beperkt tot de vervanging van de beschadigde onderdelen. Zijn wettelijke aansprakelijkheid kan niet worden ingeroepen eens het tuinhuis is gemonteerd. In alle gevallen wordt de klant ten zeerste aangeraden een gedetailleerde inventaris te maken van de stukken volgens de naamlijst op het montageplan en pas daarna te beginnen met de eigenlijke montage. De aansprakelijkheid van de leverancier kan niet worden ingeroepen tenzij het montageplan strikt werd nagevolgd.

In het kader van de verantwoordelijkheid van de klant

Elke aanvraag tot vervanging van stukken die bij montage in slechte staat bleken of die zich in onvolkomen staat bevinden ten gevolge van externe factoren (onweer, diverse ongelukken, ...) zal worden voldaan, maar zal worden gefactureerd. Hetzelfde geldt bij niet-naleving van de montage-instructies of voor aanvragen die ons niet binnen de gestelde termijn bereiken.

De aandacht dient te worden gevestigd op het feit dat de leverancier nergens verplicht is een voorraad van tuinhuisonderdelen aan te houden die niet langer deel uitmaken van zijn gamma.

AANBEVELINGEN :

Het is de verantwoordelijkheid van de koper ervoor te zorgen dat het tuinhuis niet kan worden meegesleurd door de wind. Daarom wordt ten zeerste aangeraden de profielen die de eerste rij vormen stevig te verankeren in de grond en het tuinhuis over de volledige hoogte vast te zetten met gebruik van de onweerkit die werd meegeleverd met het tuinhuis of die, naargelang het model, apart beschikbaar is in de winkel. In alle gevallen dient het gekozen systeem het natuurlijke krimpen en uitzetten van het hout in functie van de seizoenen toe te laten. Het is dus van groot belang dat de structuur nooit wordt geblokkeerd.

Alsook, bij lage temperatuur of hevige wind, kan het noodzakelijk zijn de "coaltar" onder de shingles te verwarmen. Indien nodig kan de roofing of shingles ook gelijmd worden. Indien u er voor kiest uw blokhut op een betonvloer te plaatsen, vergeet er dan niet voor te zorgen dat die goed geïsoleerd is tegen opstijgend vocht.

Regelmatig beitsen van het tuinhuis is noodzakelijk om de levensduur van het hout te garanderen. Beitsen dient met de nodige regelmaat te worden herhaald en met gebruikmaking van de geëigende producten. Het is af te raden de binnenkant van de blokhut te beitsen.



=



F

DELAIS :

Le fournisseur met tout en œuvre pour fournir les pièces concernées le plus rapidement possible. Il est à noter toutefois qu'il ne peut être tenu à aucun délai.

RESPONSABILITE :

La responsabilité du fournisseur est limitée au remplacement des pièces défectueuses. Sa responsabilité juridique ne peut être mise en cause une fois l'abri monté. Dans tous les cas, il est fortement conseillé au client de procéder à un inventaire exhaustif des pièces selon la nomenclature figurant dans le plan de montage et de ne prévoir le montage effectif qu'après cette vérification.

La responsabilité du fournisseur ne peut être engagée que si le plan de montage a été scrupuleusement respecté.

Dans le cadre de la responsabilité du client

Toute demande destinée à remplacer des éléments détériorés au montage ou du fait d'éléments extérieurs (tempête, accidents divers...) pourra être satisfaite mais sera facturée. Il en est de même en cas de non respect des instructions de montage ou pour les demandes formulées hors délai. Il est à noter que le fabricant n'est pas tenu de conserver en stock des pièces nécessaires au montage des abris qui ne figurent plus dans sa gamme.

CONSEILS :

Il appartient au monteur de s'assurer que son abri ne risque pas d'être emporté par le vent, pour cela, il est fortement conseillé de fixer au sol les profils constituant la lère rangée et de solidariser l'abri sur toute sa hauteur à l'aide du kit tempête livré avec l'abri ou disponible en magasin suivant les modèles. Dans tous les cas le système choisi doit permettre le mouvement naturel du bois en fonction des saisons, il est donc impératif de ne jamais bloquer la structure de l'abri.

De même, par basse température ou par grand vent, il peut être nécessaire de chauffer les galets de coaltar sous les shingles. Au besoin, le roofing ou les shingles peuvent aussi être collés. Si vous choisissez de montrer votre abri sur une dalle de béton, n'oubliez pas d'isoler la dalle du sol à l'aide d'un film approprié afin d'éviter les remontées d'humidité.

Le lasurage régulier de l'abri est indispensable à sa durée de vie, il doit être effectué régulièrement avec des produits appropriés. Il est déconseillé de lasurer l'intérieur de l'abri.

GB

TERMS :

The supplier shall bring every effort to bear to ensure fast delivery of the replacement sections. However, the supplier remains unbound by any commitments in terms of delivery times in this respect.

LIABILITY :

The supplier's liability is confined to the replacement of flawed sections. His legal liability cannot be invoked once the garden shed has been fully assembled.

In all cases, customers are strongly recommended to compile a detailed inventory of the sections setting out from the name list on the assembly instructions before embarking on actual assembly operations.

The supplier's liability can only be invoked if the assembly instructions have been strictly complied with.

Under the responsibility of the customer

All applications for replacements of sections which proved to be in flawed condition upon assembly or which proved to be flawed as a result of extraneous factors (gales and storms, various types of accidents, ...) will be met but will also be duly invoiced.

The same applies in cases of non-compliance with assembly instructions or to applications which fail to reach us within the time span as defined above.

A due focus of attention should also go out to the fact that it is nowhere incumbent on the supplier to maintain a stock of sections for garden sheds which have been delisted from the available ranges he offers.

RECOMMENDATIONS :

It is the buyer's responsibility to bring to bear all necessary measures to ensure his garden shed is not swept away by the wind. Which is why customers are strongly recommended to ensure a solid ground anchoring of the profiles making up the first row and to secure the garden shed across its entire height using the bad weather kit supplied along with the garden shed or which, depending on the model, is separately available from the shop. In all cases, the system chosen is to allow for the natural swell and shrinkage of the wood in consideration of the weather seasons. It is imperative that the structure is never obstructed as such.

The frequent restaining of the garden shed is necessary to guarantee the wood's longevity. Please restrain at regular intervals, using the appropriate materials.

D

Planung :

Es ist wichtig, diese Montageanleitung vollständig durchzulesen, bevor Sie mit dem Aufbau Ihres Produkt beginnen. So vermeiden Sie Probleme und unnötigen Zeitverlust. Das Produkt wurde mehrfach kontrolliert, prüfen Sie dennoch vor dem Aufbau den Bausatz auf Vollständigkeit, spätestens 10 Tage nach Lieferung.

Fundament :

Verwenden Sie beim Erstellen Ihres Fundamentes größte Sorgfalt. Fertigen Sie das Fundament so, daß die Oberkante ca. 5 cm über die Bodenfläche hinausragt. Das Fundament muss absolut in der Waage und entwässert sein, damit alle Auflagehölzer plan aufliegen. Damit der direkte Kontakt der Auflagehölzer zum Erdboden/Fundament vermieden wird, schneiden Sie

Bitumen-/Mauersperrbahnen (gehören nicht zum Lieferumfang) in Streifen und legen Sie diese unter die Auflagehölzer. Wir machen folgende Fundamentvorschläge:

- Streifenfundament
- geschüttetes Betonfundament
- Betonplattenfundament

Für ein dauerhaftes Fundament sind Untergrund, Rechtswinkeligkeit und ebene Oberflächen die wichtigsten Voraussetzungen. Mit einem guten Fundament hält Ihr Produkt viele Jahre länger. Lassen Sie sich ggf. von einem Fachmann beraten bzw. lassen Sie das Fundament von einem Fachmann erstellen.

Lagerung bis zur Montage :

Das Produkt besteht aus hochwertigem Fichtenholz und wird unbehandelt geliefert. Achtung, der Bausatz ist nicht wasserdicht verpackt. Die Folie schützt das Holz nur gegen Verschmutzung. Lagern Sie daher den Bausatz bis zur endgültigen Montage trocken und nicht direkt auf dem Erdboden, geschützt vor Witterungseinflüssen (Nässe, Sonneneinwirkung, etc.). Ware bitte nicht in einem geheizten Raum aufbewahren!

Vorbereitung/Pflege/Holzschutz :

Vor der Montage müssen alle Bauteile, auch im Innenbereich, ausreichend mit einem tiefenwirksamen Holzschutzgrund behandelt werden (vorbeugender Schutz gegen Bläue und Schimmel). Verwenden Sie für den Endanstrich eine wetterbeständige Lasur, auch im Innenraum, mit hohem physikalischem Schutz, die das Holz vor Feuchtigkeit und UV-Strahlung schützt. Die Lasur sollte zugleich feuchtigkeitsregulierend, wasserabweisend und lichtecht sein. Zudem sollten Sie darauf achten, das die Lasur ausreichend Farbpigmente enthält, da ansonsten die Gefahr besteht, das sich das Holz grau verfärbt. Bitte keinen Lack verwenden! Lassen Sie sich ausführlich bei Ihrem Fachhändler über den

Aanbeveling :

Het is aangeraden om alvorens te schroeven een gat te boren. Zo zal vermeden worden dat het hout splijt!

Conseil :

Il est recommandé de faire un avant-trou avant de visser. Cela empêchera le bois de se fissurer!

Recommendation :

It is recommended to drill a hole before screwing. This will prevent the wood from splitting!

Empfehlung :

Es wird empfohlen, vor dem Schrauben ein Loch zu bohren. Dadurch wird verhindert, dass das Holz splittert!





S8369

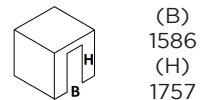
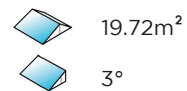
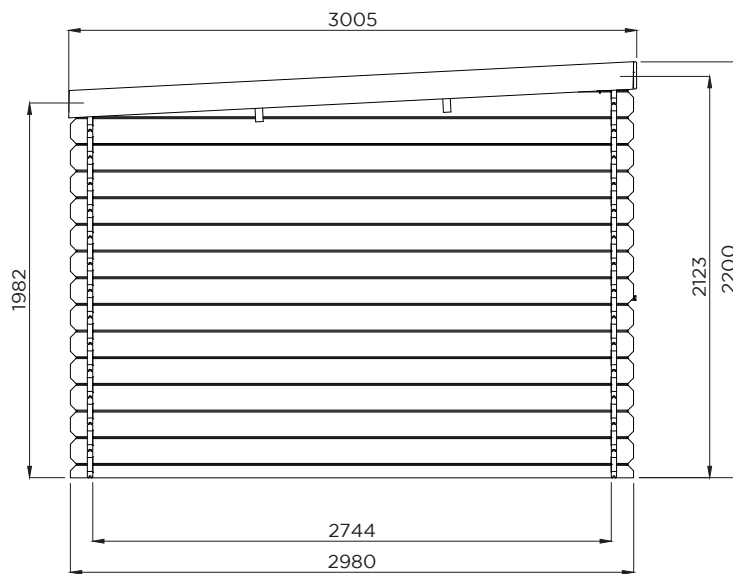
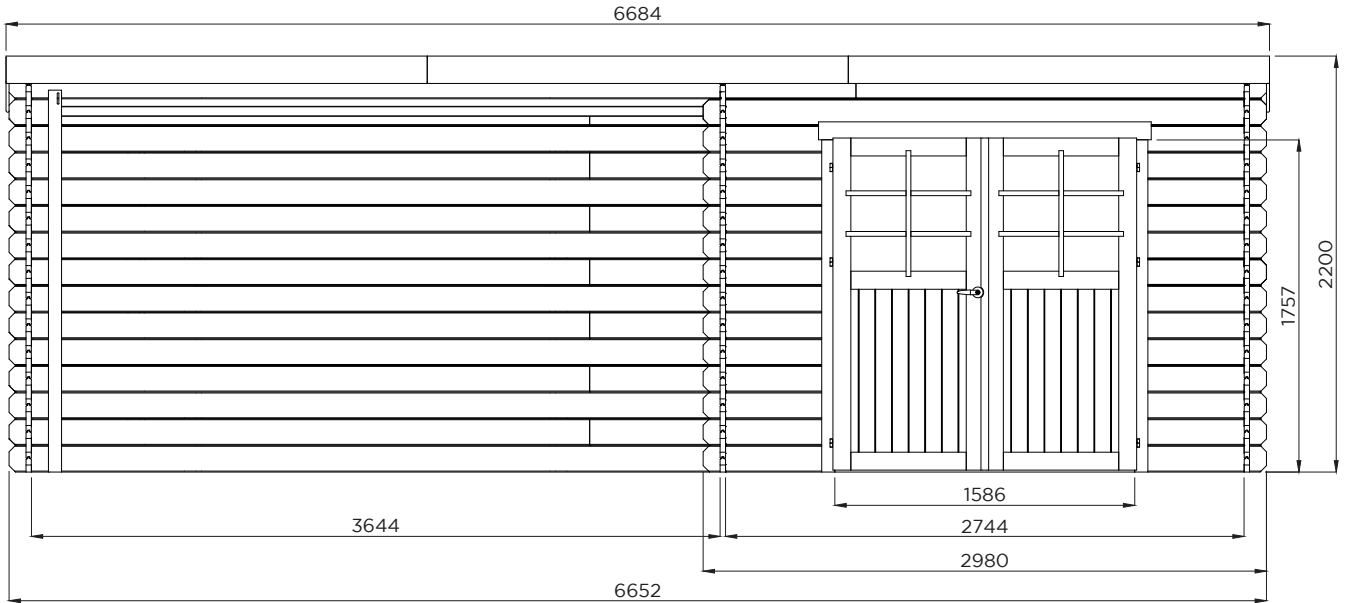

Industriepark 8
8587 Spiere-Helkijn

CreateDate: 27.03.2023
SaveDate: 27.03.2023
PlotDate: 27.03.2023

Deze technische tekening, montagehandleiding, afgeleide of detail ervan kan beschermd zijn door intellectuele eigendomsrechten en niets daarvan mag zonder schriftelijke toestemming van Solid NV worden gereproduceerd of gebruikt; anders dan het downloaden, het bekijken daarvan op een enkele computer en/of printen van een enkele hardcopy ten behoeve van persoonlijk, niet bedrijfsmatig gebruik. Elk ander gebruik van deze informatie (inclusief, maar niet beperkt tot, het geheel of gedeeltelijk reproduceren, de verdere verspreiding of distributie ervan onder welke vorm dan ook) is verboden en kan strafrechtelijk vervolgd worden. Met dank voor uw medewerking.

ROHAN
EAN code: 5412025083695



S8369

Mogelijkheid / Possibilité / Possibility / Möglichkeit

Model A

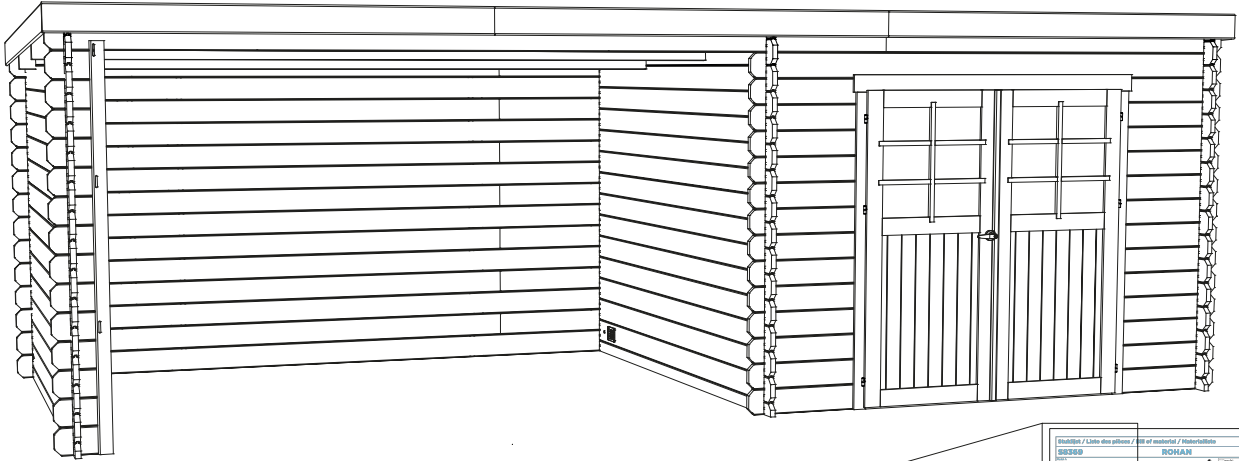

Ga verder met de handleiding van **S8369 Model A.**

Continuer avec le manuel de **S8369 Model A.**

Continue with the manual from **S8369 Model A.**

Fahren Sie mit dem Handbuch von fort **S8369 Model A.**

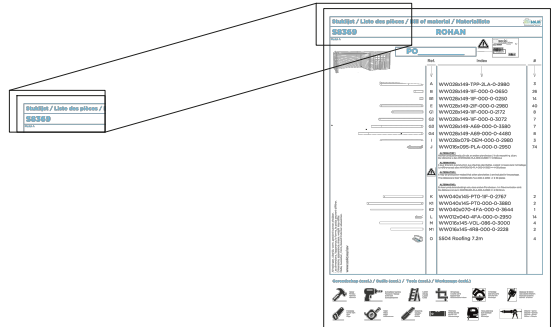

Model B

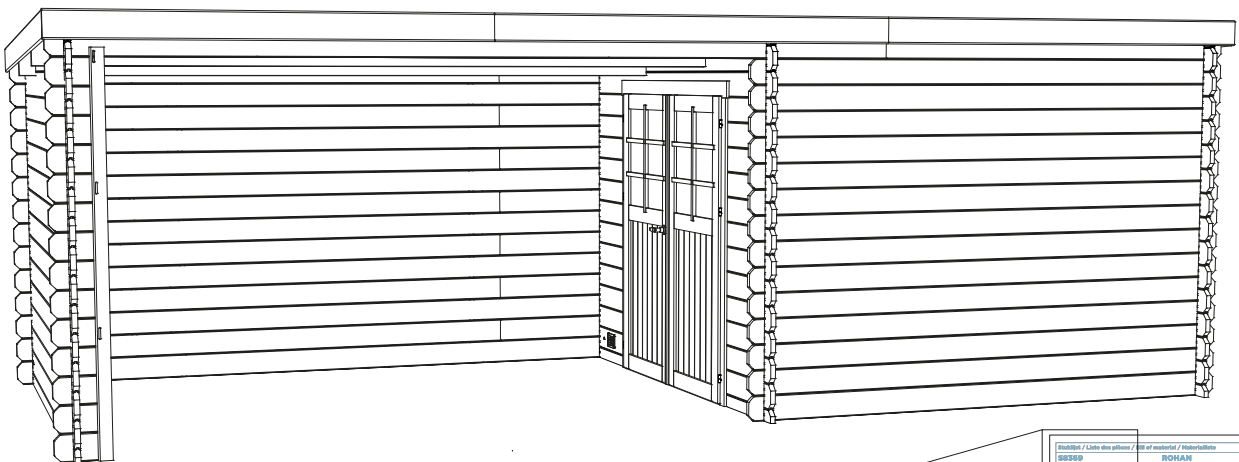

Ga verder met de handleiding van **S8369 Model B.**

Continuer avec le manuel de **S8369 Model B.**

Continue with the manual from **S8369 Model B.**

Fahren Sie mit dem Handbuch von fort **S8369 Model B.**

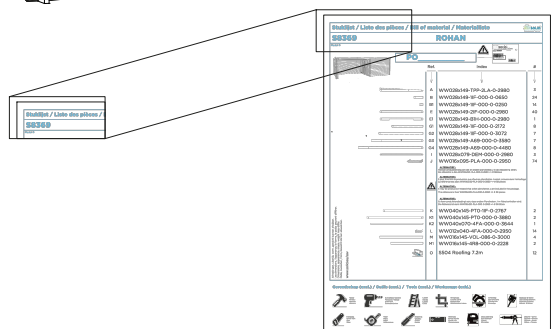

S8369

ROHAN

Model A

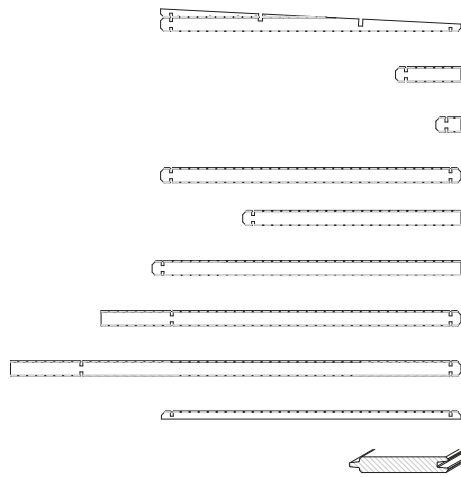
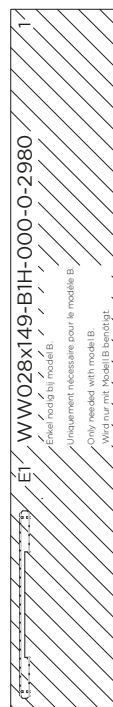
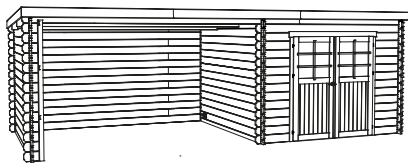

Ref.	Index	#
A	WW028x149-TPP-2LA-0-2980	3
B	WW028x149-1IF-000-0-0650	26
B1	WW028x149-1IF-000-0-0250	14
E	WW028x149-2IF-000-0-2980	40
G1	WW028x149-1IF-000-0-2172	8
G2	WW028x149-1IF-000-0-3072	7
G3	WW028x149-A69-000-0-3580	7
G4	WW028x149-A69-000-0-4480	8
I	WW028x079-DEM-000-0-2980	3
J	WW016x095-PLA-000-0-2950	74
<p>ALTERNATIEF : Het kan productiematig zijn dat er andere plankettes J in de verpakking zitten. De referentie is dan WW016x120-PLA-000-0-2950 => # 58stuks</p> <p>ALTERNATIVE : Il peut être lié à la production que d'autres plankettes J soient incluses dans l'emballage. La référence est alors WW016x120-PLA-000-0-2950 => # 58 pièces</p> <p>ALTERNATIVE : It may be production-related that other plankettes J are included in the package. The reference is then WW016x120-PLA-000-0-2950 => # 58 pieces</p> <p>ALTERNATIVE : Es kann produktionsbedingt sein, dass andere Planchetten J im Paket enthalten sind. Die Referenz ist dann WW016x120-PLA-000-0-2950 => # 58 Stück</p>		
K	WW040x145-PT0-1IF-0-2767	2
K1	WW040x145-PT0-000-0-3880	2
K2	WW040x070-4FA-000-0-3644	1
L	WW012x040-4FA-000-0-2950	12
M	WW016x145-VOL-086-0-3000	2
M1	WW016x145-4R8-000-0-2228	3
O	S504 Roofing 7.2m	4

Afmetingen, uiterlijk, vorm, gewicht kunnen afwijken.
Les dimensions, l'apparence, la forme, le poids peuvent différer.
Dimensions, appearance, shape, weight may differ.
Maße, Aussehen, Form, Gewicht können abweichen.
www.solid.eu/sav

Gereedschap (excl.) / Outils (excl.) / Tools (excl.) / Werkzeuge (exkl.)

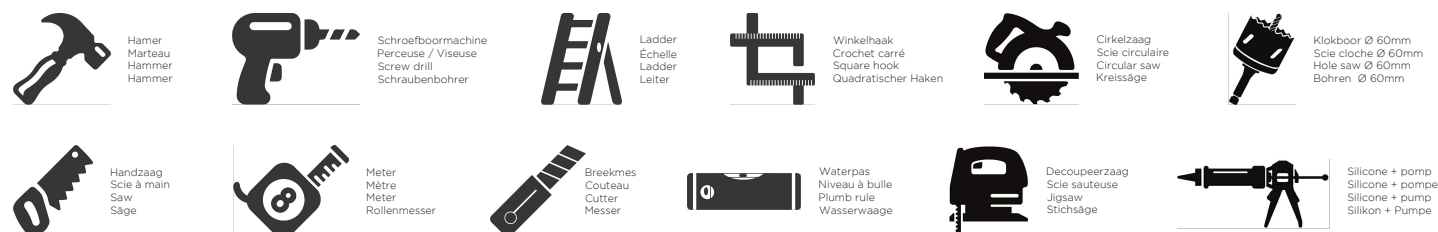

S8369

ROHAN

	Ref.	Index	#
	P	S8094C28 1 x S8094 1 x S8094-K28 1 x WW012x040-2R8-IF10-1757 1 x S8094ALU 2 x S8092-T 1 x S618 2 x S5242 (glass 630mm x 638mm) 1 x S80201 6 x S6201 1 x S673 (2/set)	1
	R	S655 2.8 x 50 #240 3.0 x 15 #520	2
	R1	S637 2.8 x 50 #100	5
	R2	S625 5.0 x 70 #20	1
	R3	S617 3.5 x 35 #20	1
	V	WW040x055-4G4-RA28-0-2020	1
	W	S6747 146	2
	Y	S522	1
	Y1	S521	1
	Z	S6746 Ventilation-kit	1

Afmetingen, uiterlijk, vorm, gewicht kunnen afwijken.
 Les dimensions, l'apparence, la forme, le poids peuvent différer.
 Dimensions, appearance, shape, weight may differ.
 Maße, Aussehen, Form, Gewicht können abweichen.
www.solid.eu/sav

Gereedschap (excl.) / Outils (excl.) / Tools (excl.) / Werkzeuge (exkl.)

Hamer Marteau Hammer	Schroefboormachine Perceuse / Visseuse Screw drill Schraubenbohrer	Ladder Échelle Ladder Leiter	Winkelhaak Crochet carré Square hook Quadratischer Haken	Cirkelzaag Scie circulaire Circular saw Kreissäge	Klokbuur Ø 60mm Scie cloche Ø 60mm Hole saw Ø 60mm Bohren Ø 60mm
Handzaag Scie à main Saw Säge	Meter Mètre Meter Rollenmesser	Breekmes Couteau Cutter Messer	Waterpas Niveau à bulle Plumb rule Wasserwaage	Decoupeerzaag Scie sauteuse Jigsaw Stichsäge	Silicone + pomp Silicone + pompe Silicone + pump Silikon + Pumpe

- I = 3
- B = 2
- B1 = 1
- G1 = 1
- G4 = 1

1

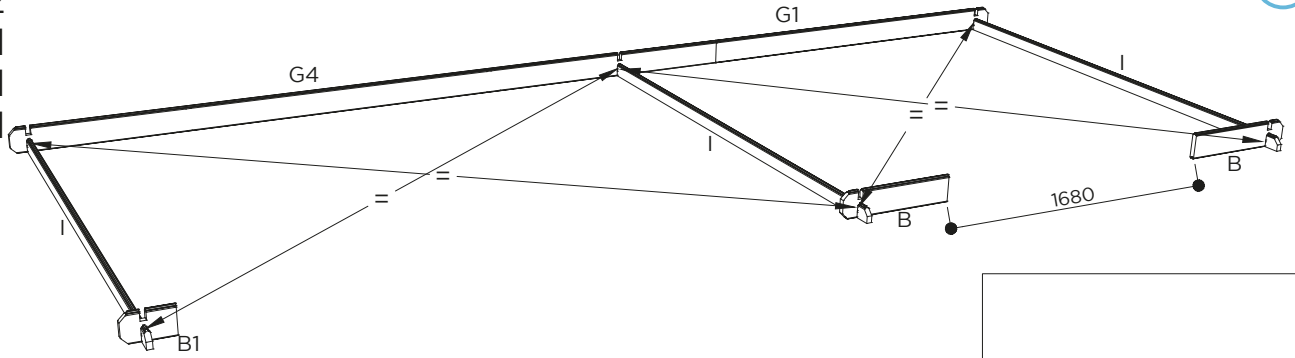

Mogelijkheid
Possibilité
Possibility
Möglichkeit

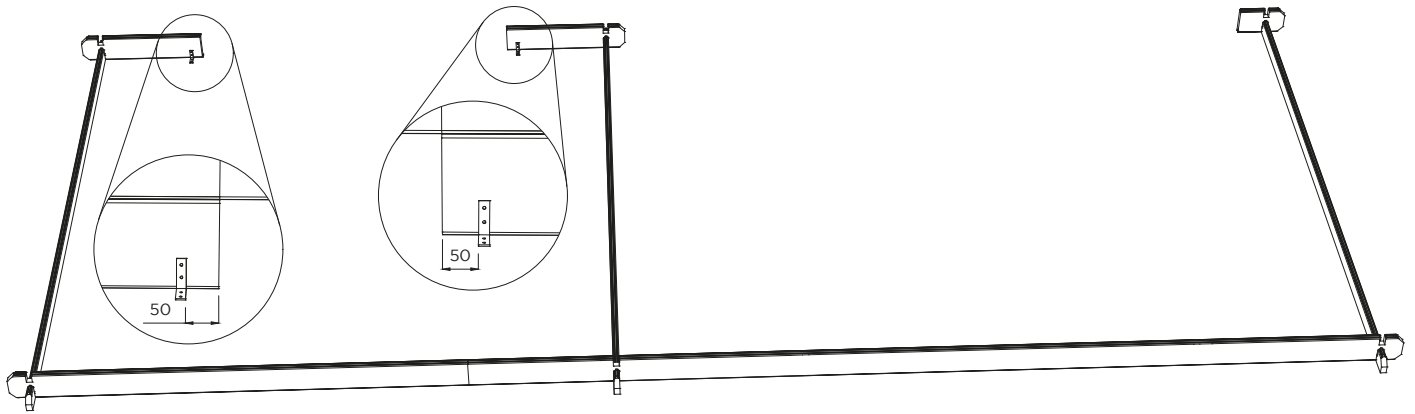
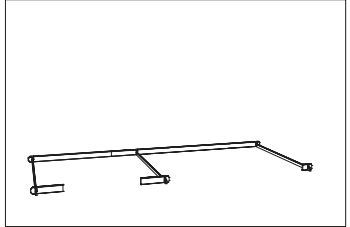

3.0 x 30 # 8

- B = 12
- B1 = 6
- E = 18
- G1 = 3
- G2 = 3
- G3 = 3
- G4 = 3

2

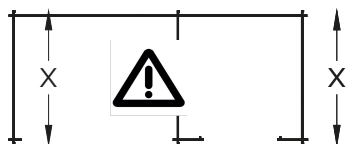
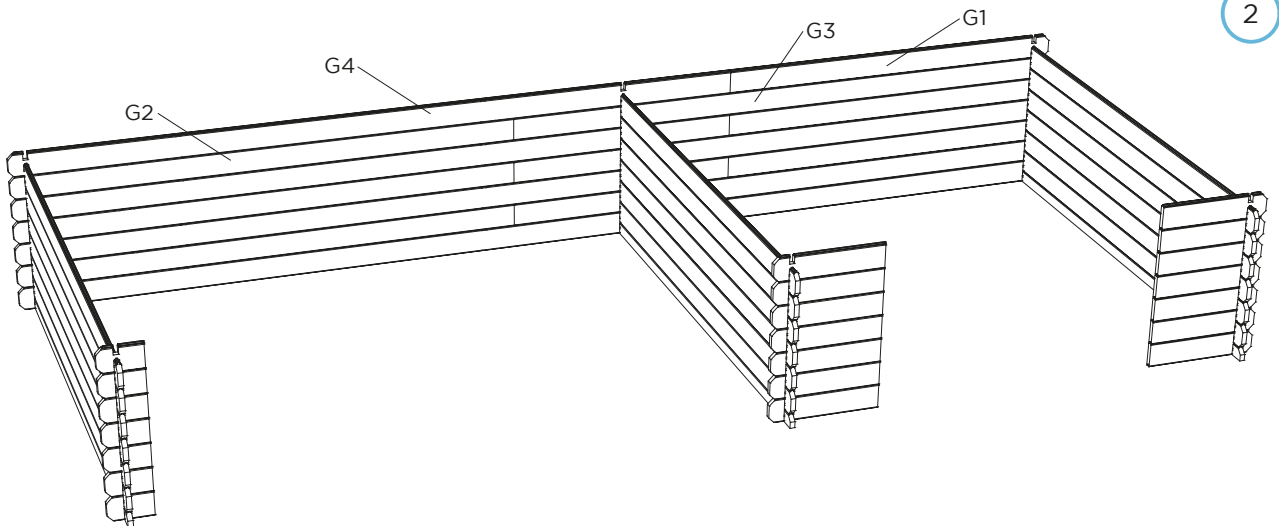

Mogelijkheid
Possibilité
Possibility
Möglichkeit

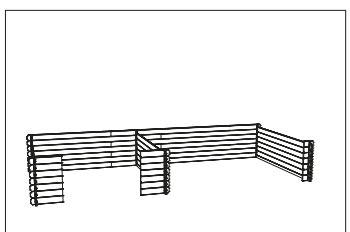

B = 12
 B1 = 6
 E = 22
 G1 = 3
 G2 = 3
 G3 = 3
 G4 = 3

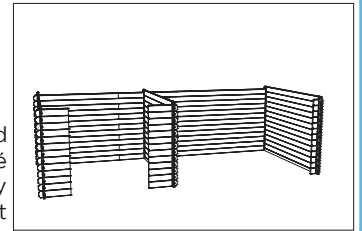
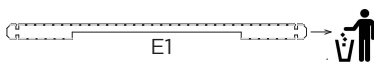
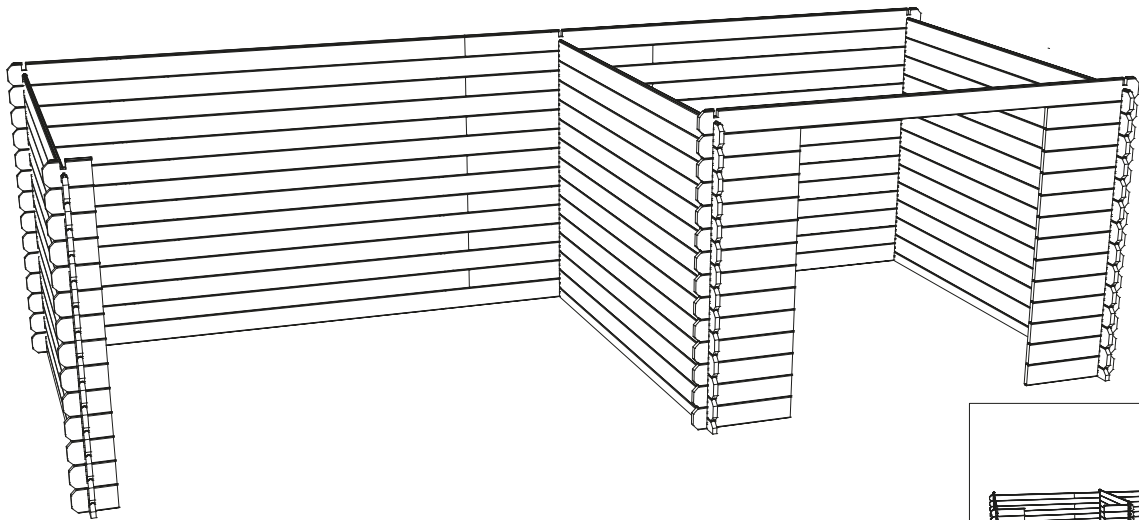

Mogelijkheid
 Possibilité
 Possibility
 Möglichkeit



(NL) INFORMATIE :

Het is niet abnormaal dat kleine openingen te zien zijn bij de montage, zowel boven de deur als bij de dakopbouw. Deze zullen na het natuurlijk drogen van het product verdwijnen, hou er evenwel rekening mee dat dit enkele weken kan duren.

(FR) INFORMATION :

Il n'est pas anormal qu'il y ait des ouvertures à voir lors du montage tant au-dessus de la porte et les fenêtres qu'en montant le toit. Ceux-ci disparaîtront après le séchage naturel du produit. Tenez cependant compte que cela peut durer quelques semaines.

(GB) INFORMATION :

It is not unusual that small openings are visible during the assembly, both above the door and in the roof. These will disappear after the natural drying of the product, keep in mind, however, that this may take several weeks.

(D) INFORMATION :

Es ist nicht abnormal, dass beim Aufbau, sowohl oberhalb der Tür als auch beim Dachaufbau kleine Öffnungen zu sehen sind. Nach der natürlichen Trocknung des Produktes werden diese verschwinden. Berücksichtigen Sie aber, dass dies einige Wochen in Anspruch nehmen kann.

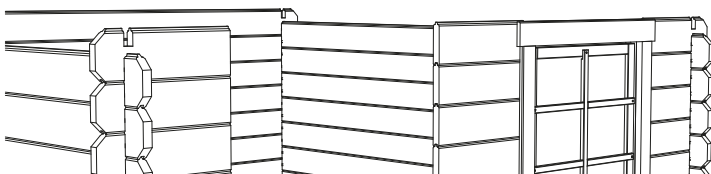
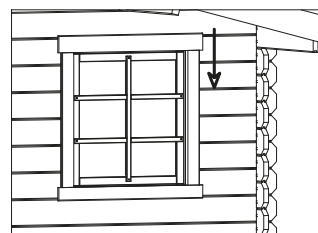
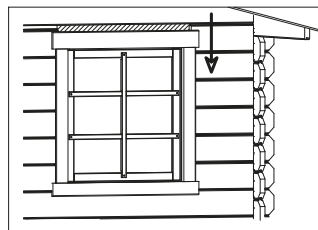
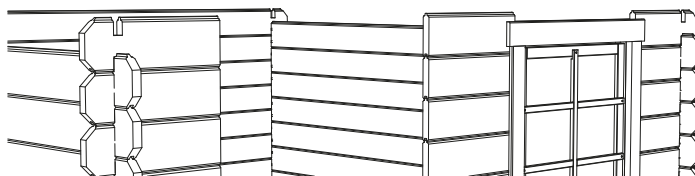

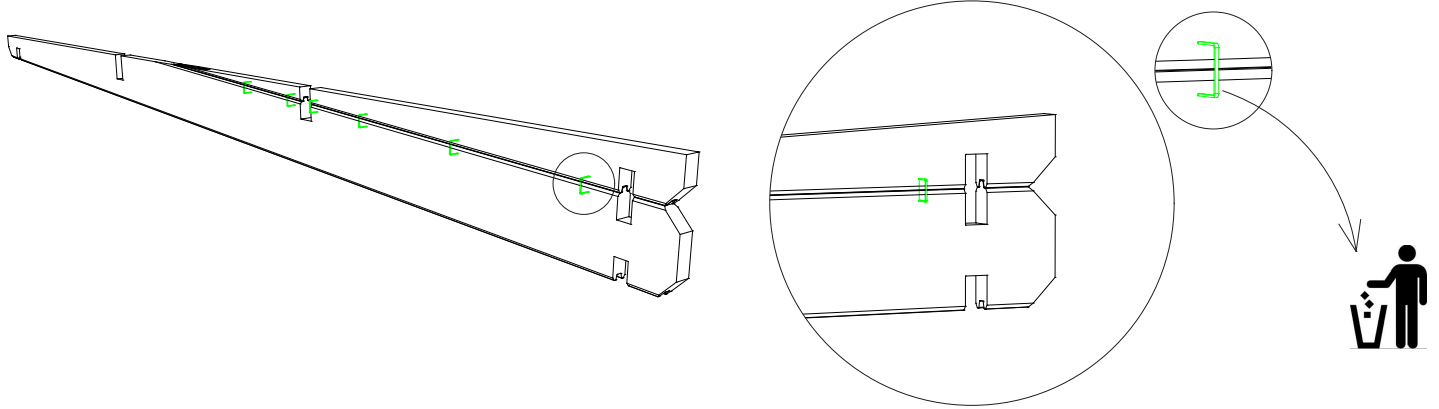

G1 = 1
 G4 = 1
 K2 = 1
 V = 1

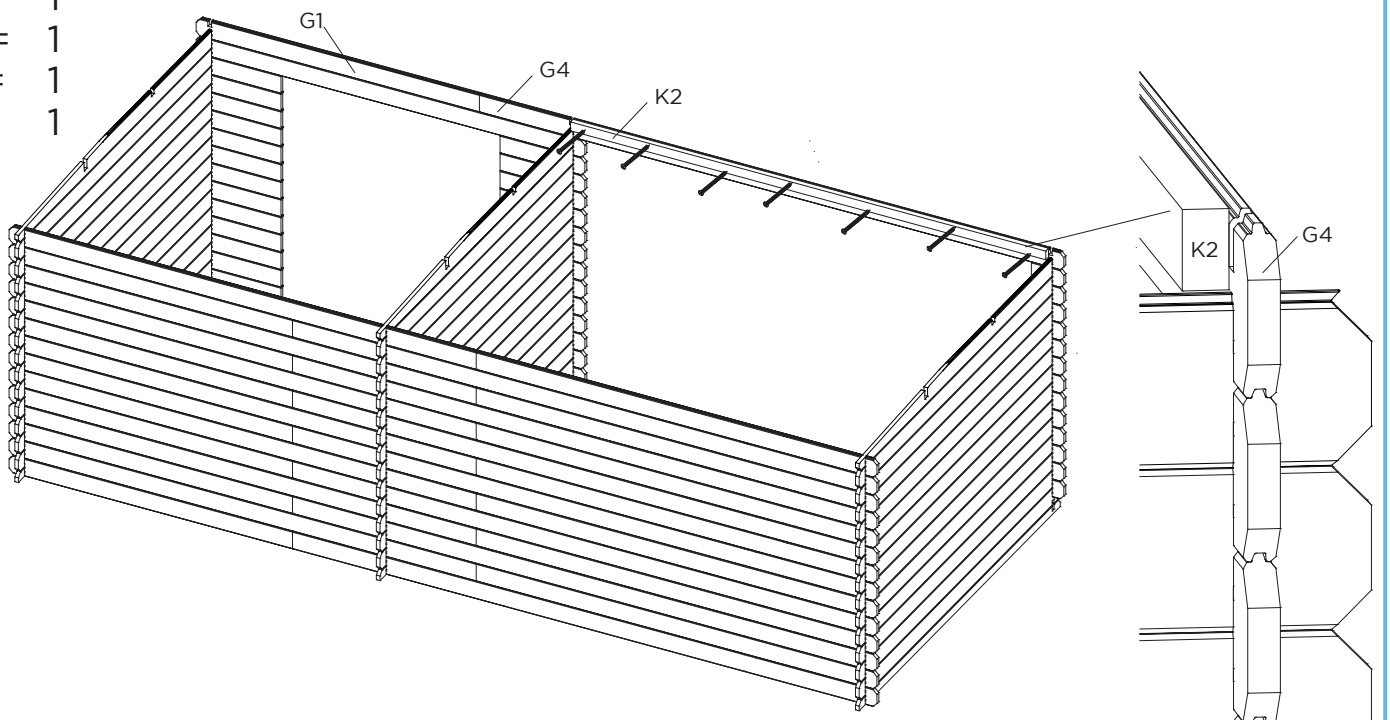

(NL) INFORMATIE :

Laat het natuurlijke krimpen en uitzetten van het hout toe in functie van de seizoenen. Bevestigingsbouten niet inbegrepen. Op de 3 plaatsen de bouten te voorzien !!

(FR) INFORMATION :

Permet au bois de rétrécir et de se dilater naturellement selon les saisons. Boulons de montage non inclus. Prévoir les boulons aux 3 endroits !!

(GB) INFORMATION :

Allows the wood to shrink and expand naturally according to the seasons. Mounting bolts not included. Provide the bolts in the 3 places !!

(D) INFORMATION :

Lässt das Holz je nach Jahreszeit auf natürliche Weise schrumpfen und sich ausdehnen. Befestigungsschrauben nicht enthalten. Stellen Sie die Schrauben an den 3 Stellen bereit !!

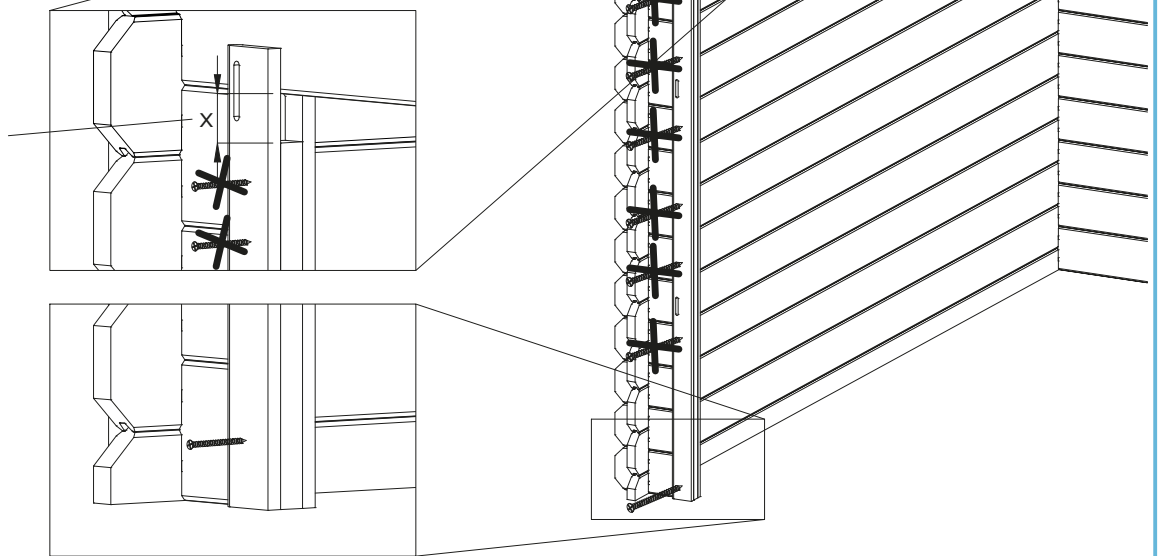

A = 3

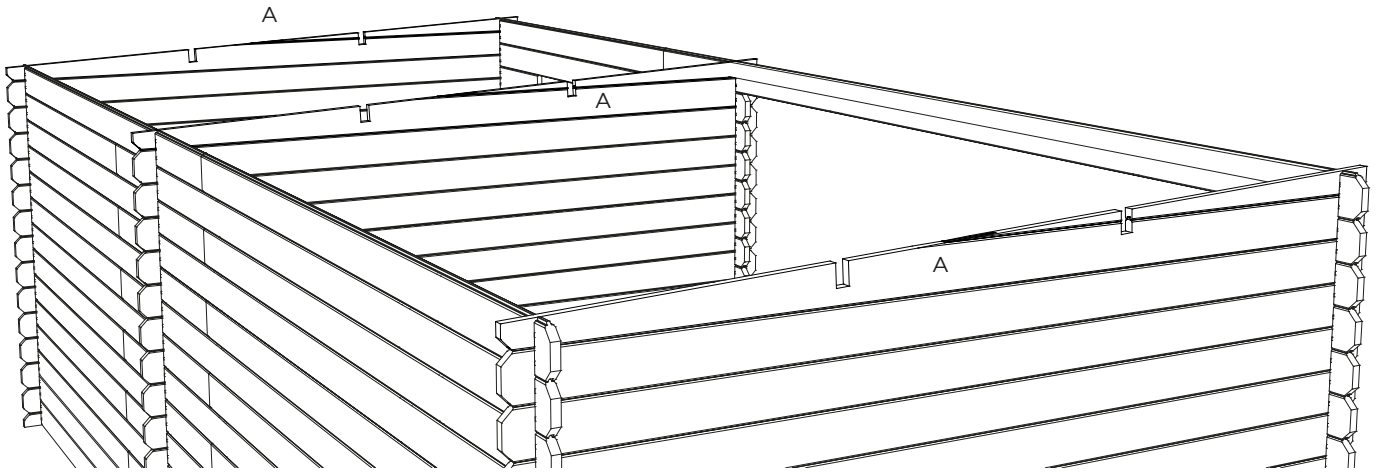

Aanbeveling / Conseil / Recommendation / Empfehlung

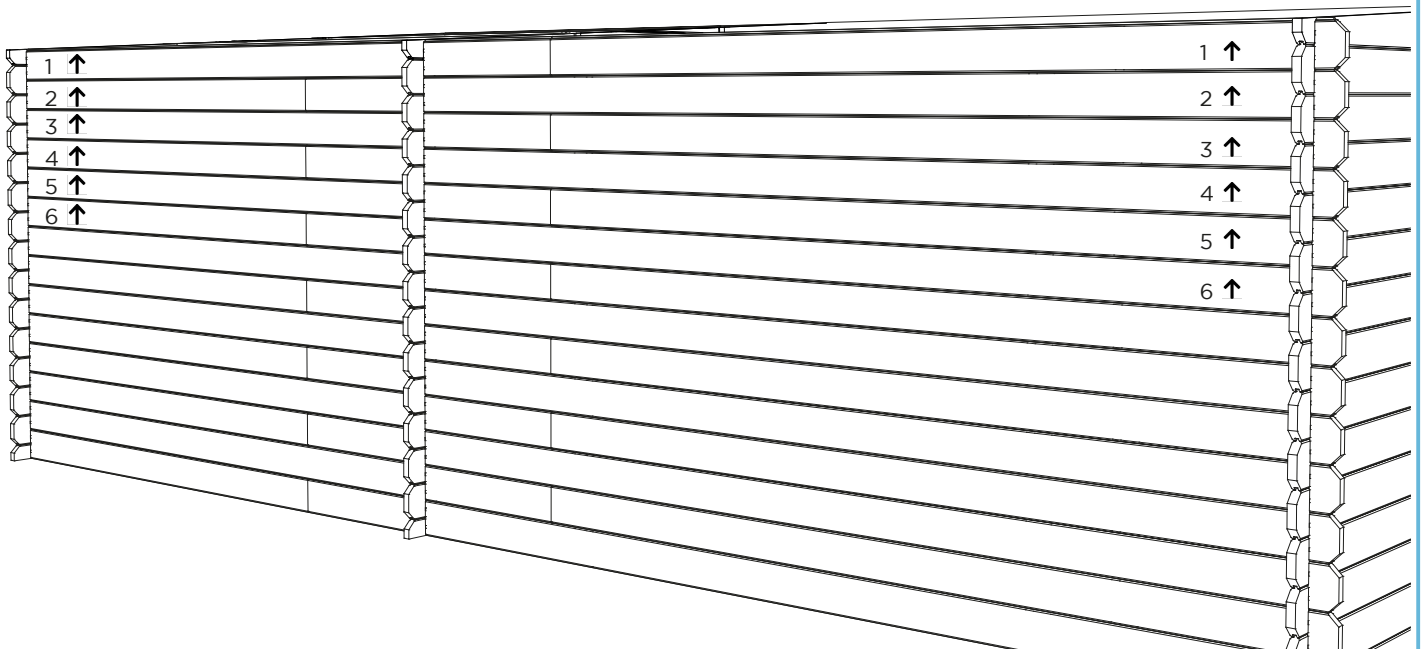
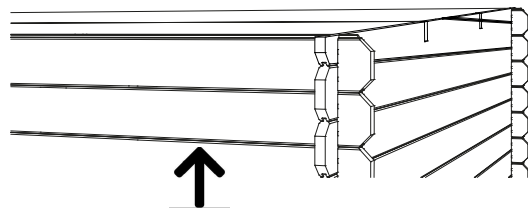
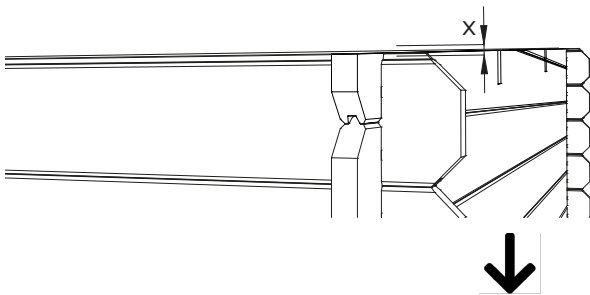







Verplicht / Obligatoire / Required / Verpflichtet

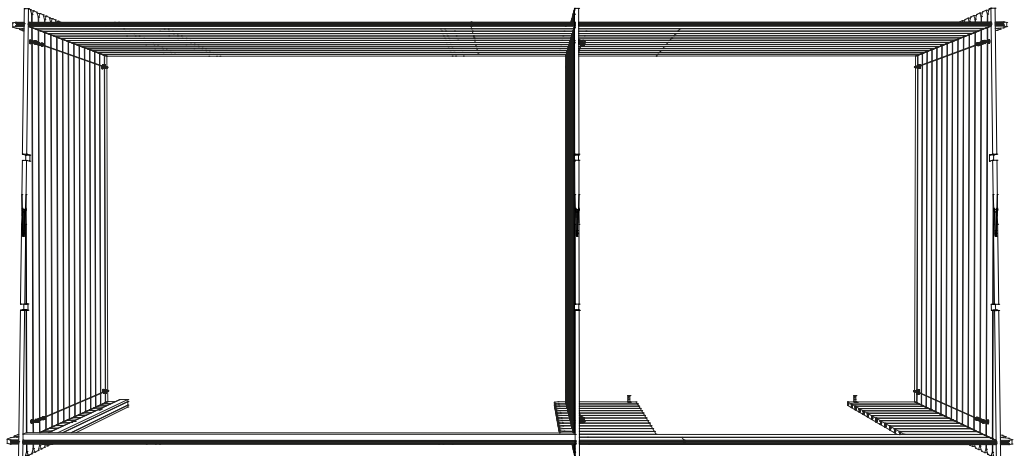
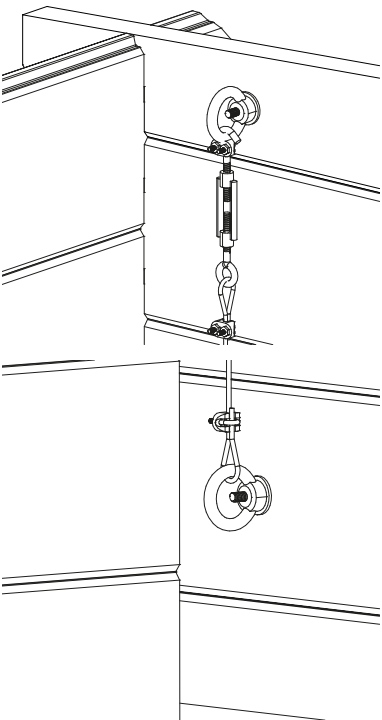
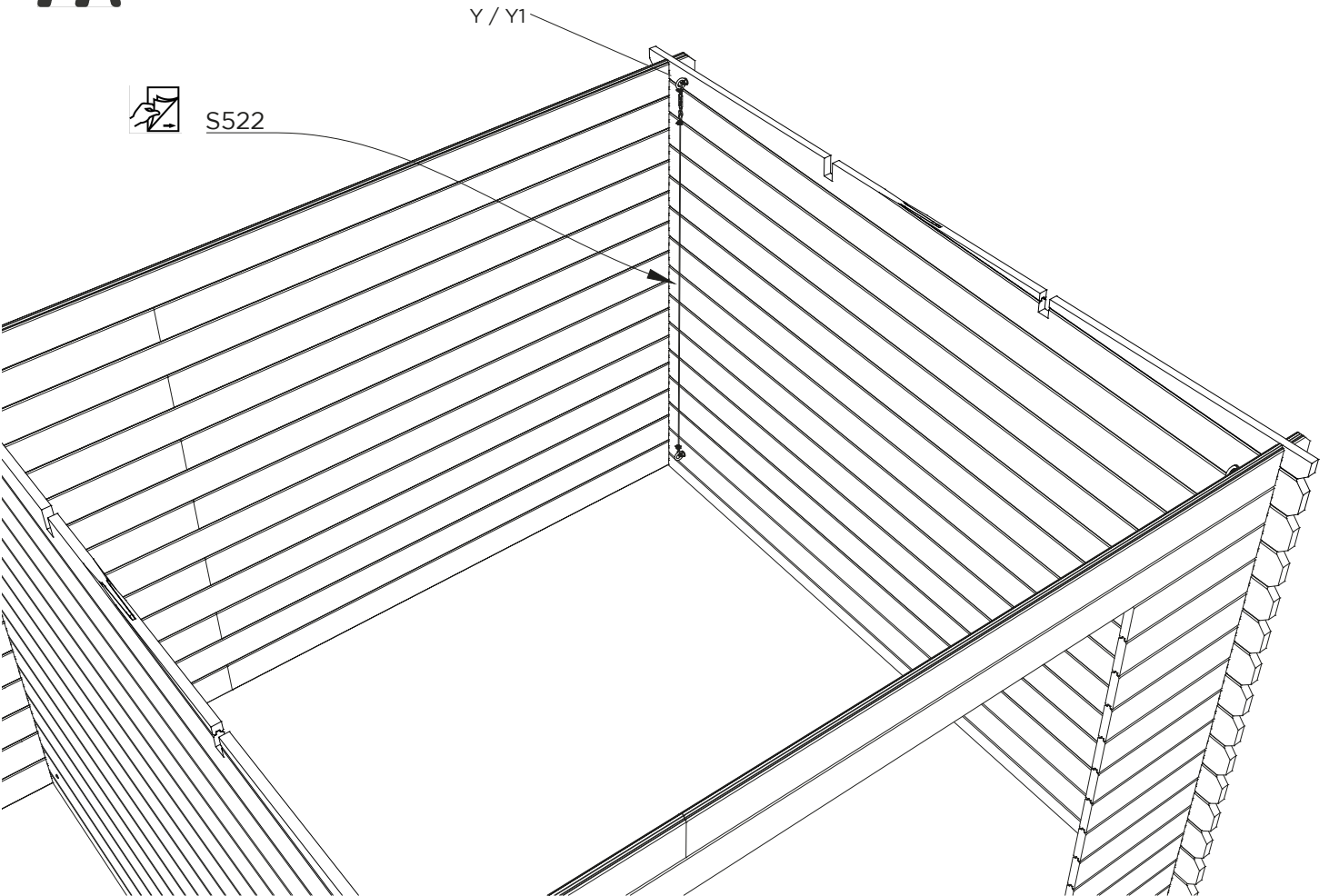

Y = 1
Y1 = 1



- K = 2
- K1 = 2
- W = 2
-  2.8 x 50 # 8
-  3.0 x 35 # 8
-  5.0 x 70 # 8

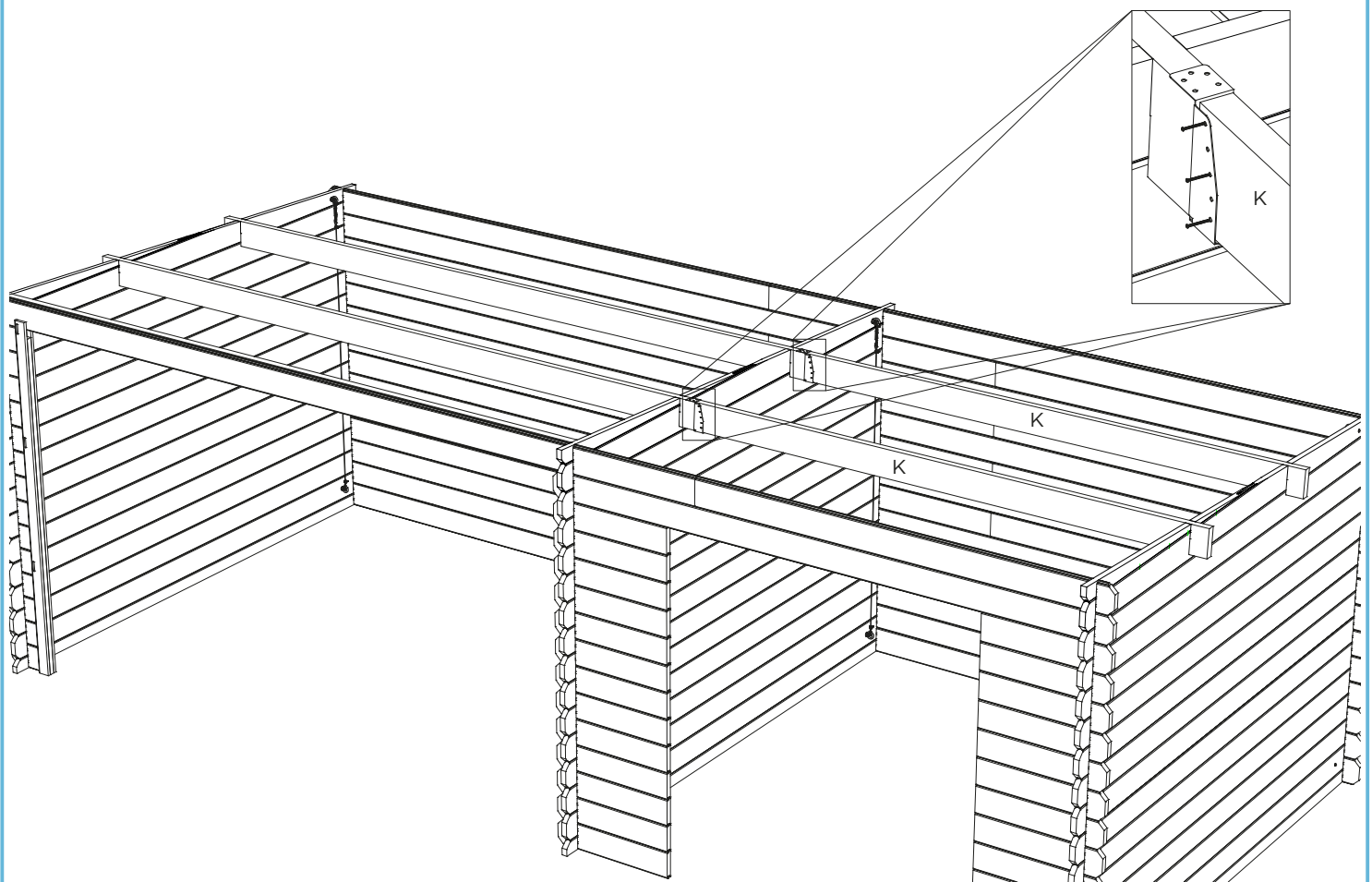
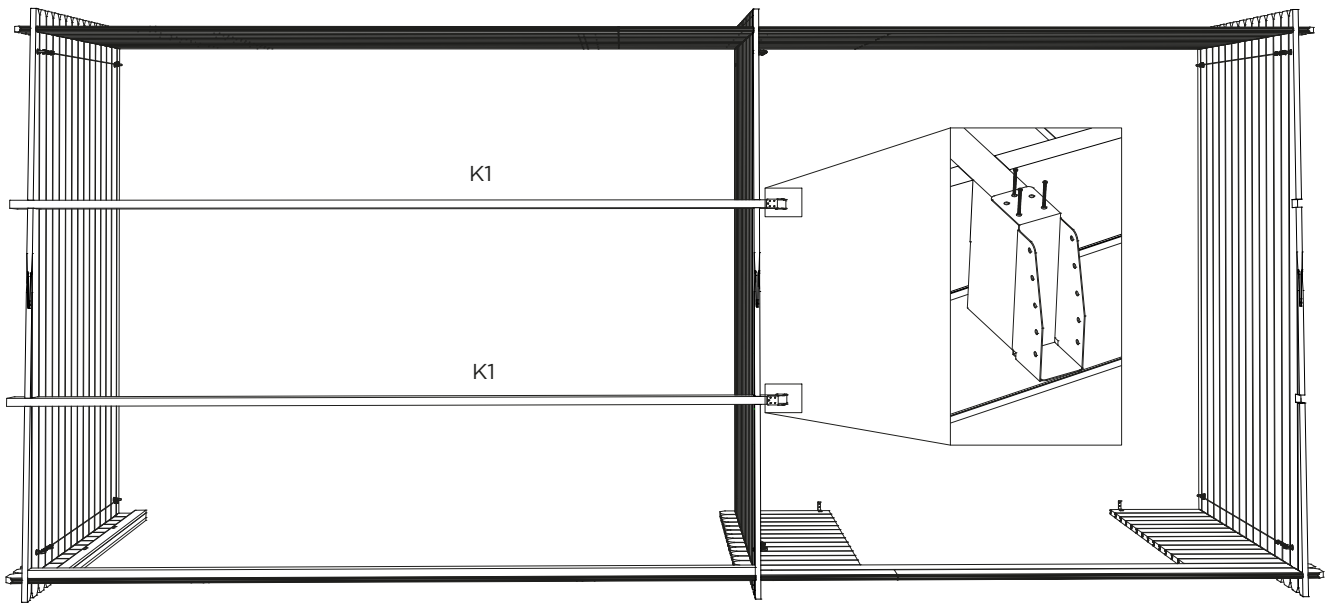

J = 74 of/ou/or/oder 58
2.8 x 50 # 592

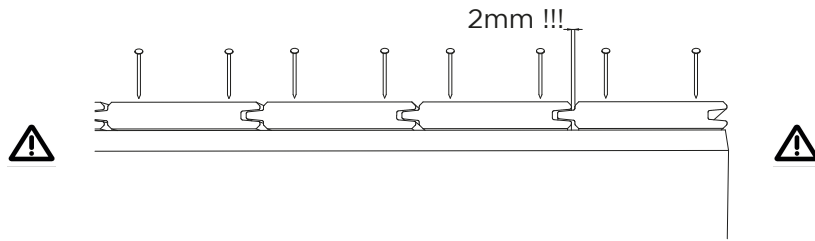
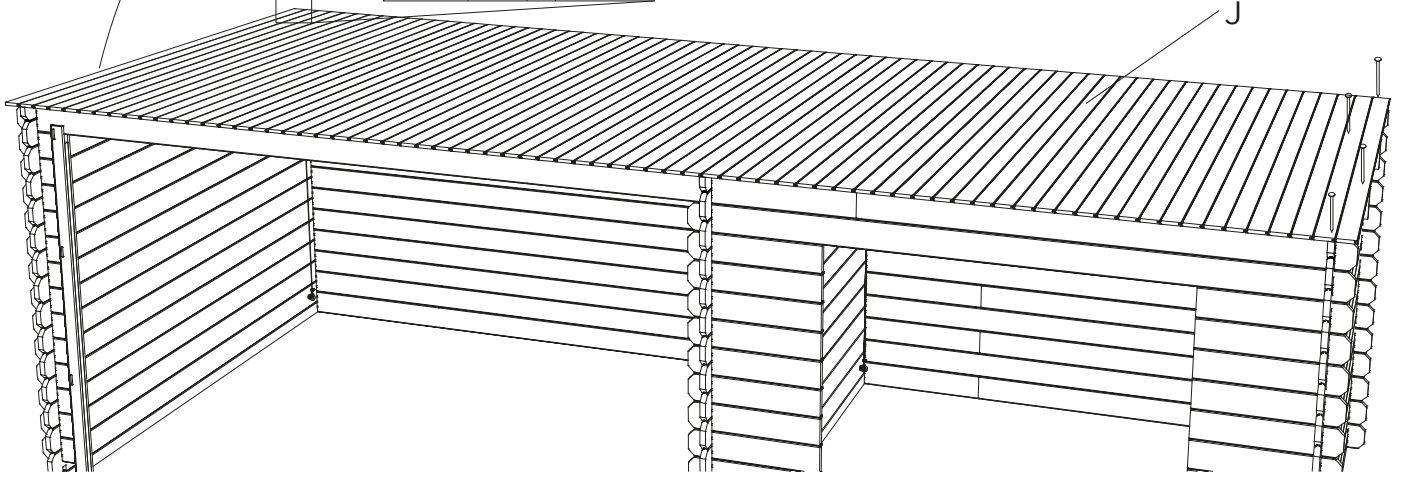
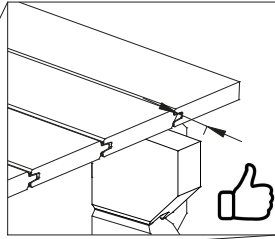
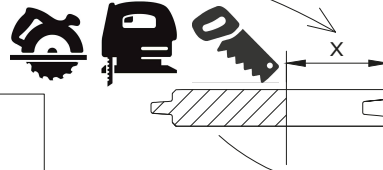

O = 4
3.0 x 15 # 20 /m²

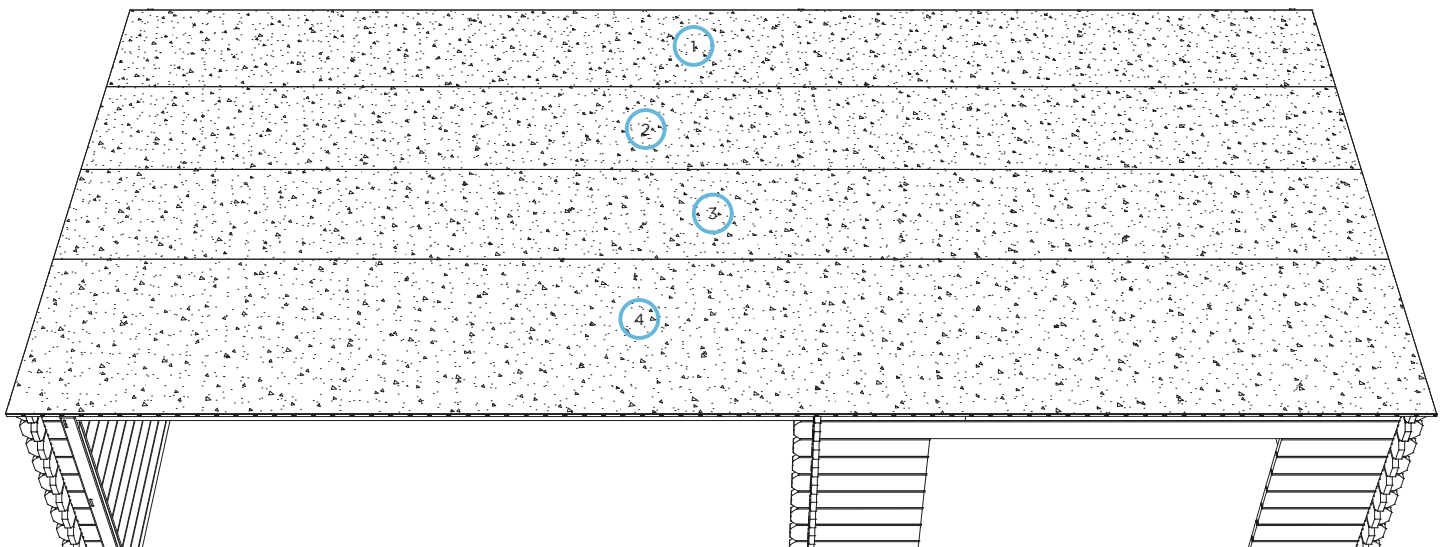
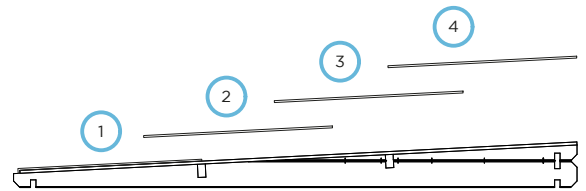
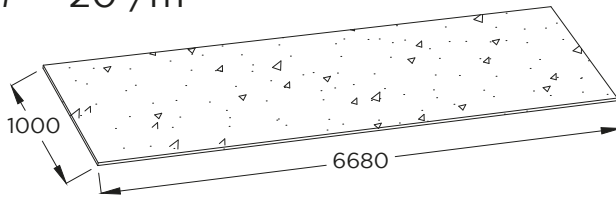

L = 12
2.8 x 50 # 56

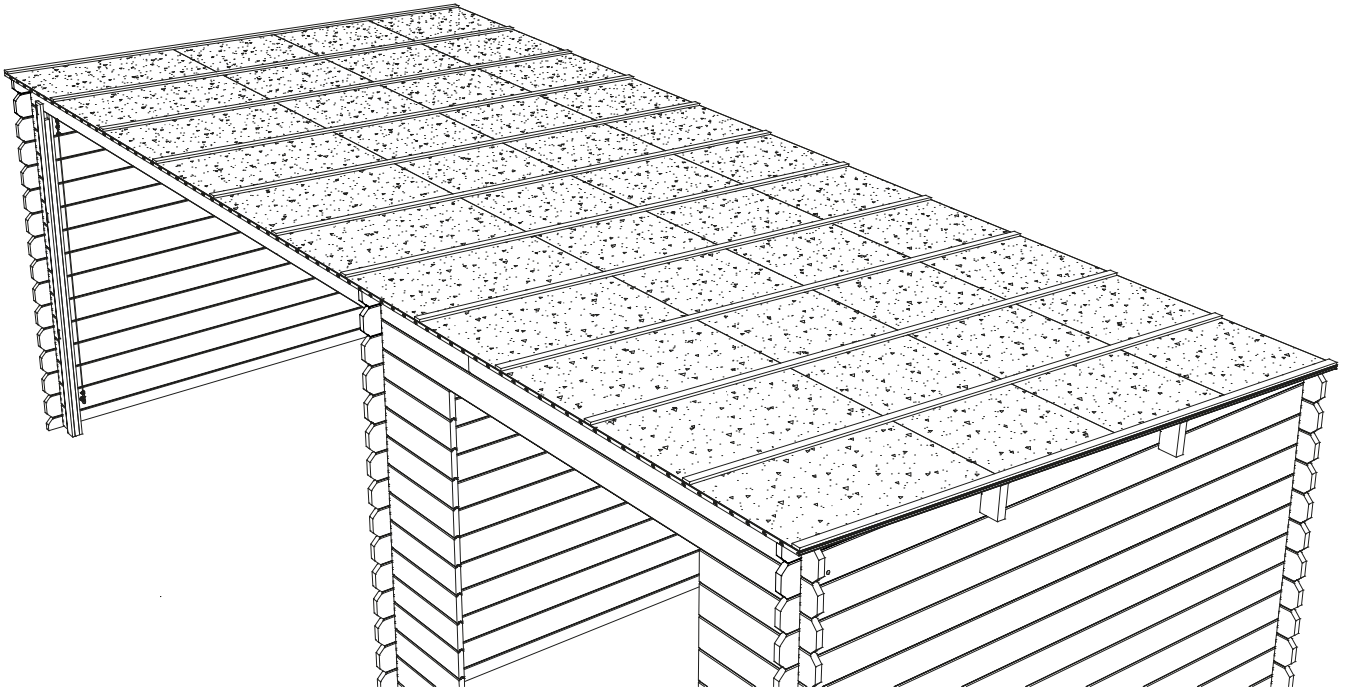

M = 2
M1 = 3
2.8 x 50 # 20

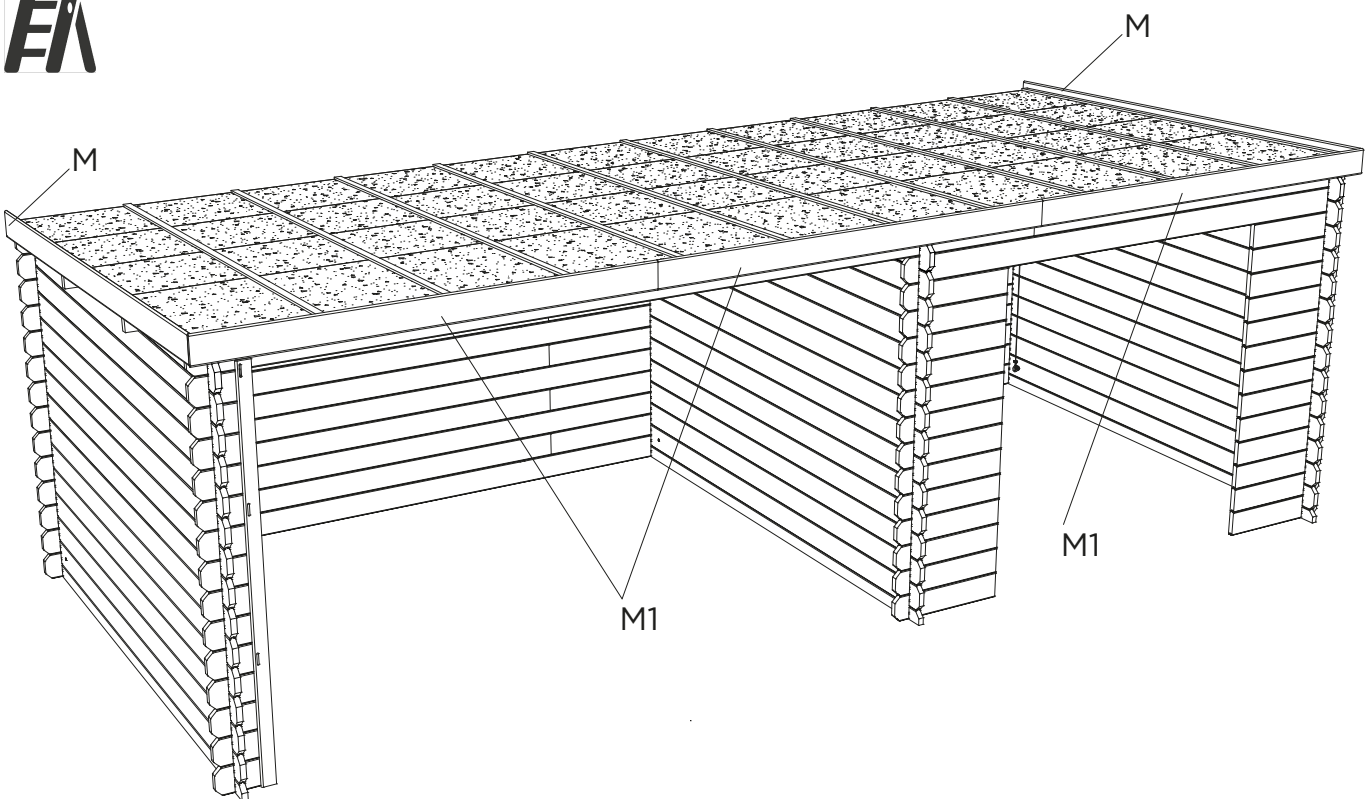

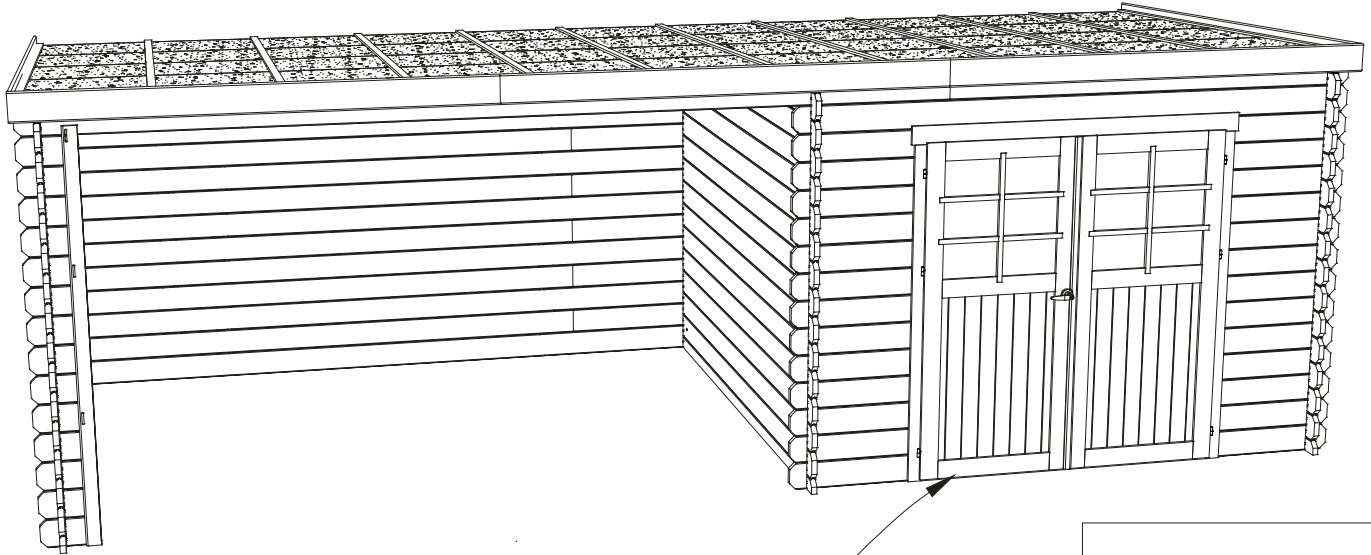

S8094C28

Mogelijkheid
Possibilité
Possibility
Möglichkeit

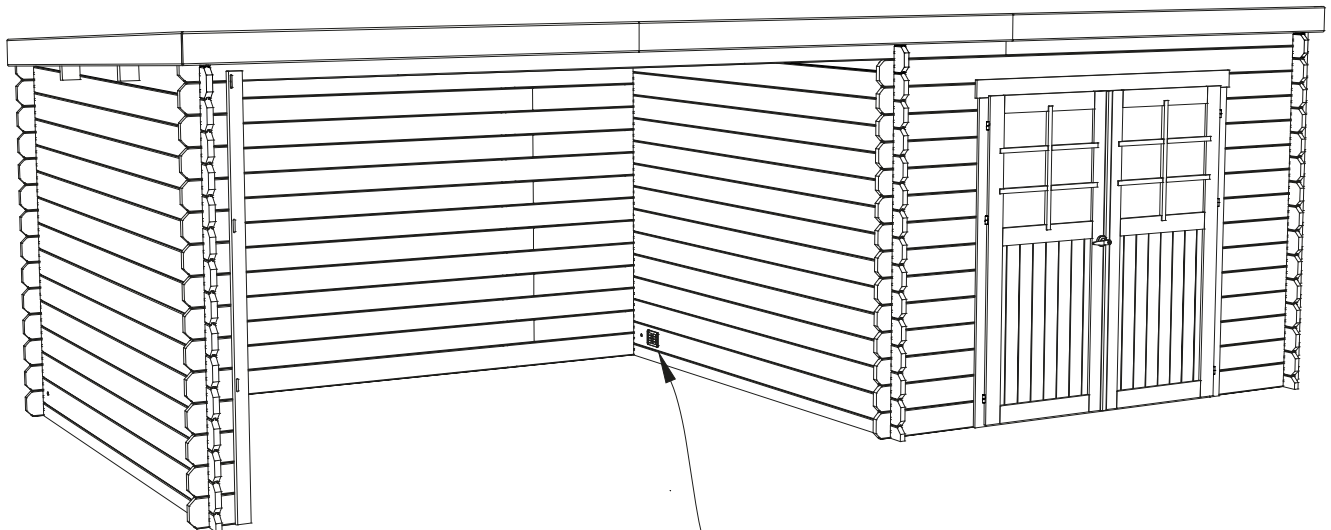
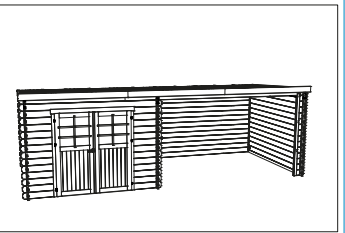

S6746 Ventilation-kit



S8369

ROHAN

Model B

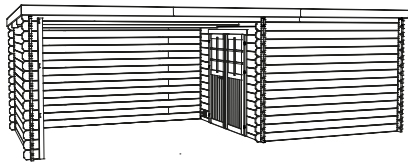

PO

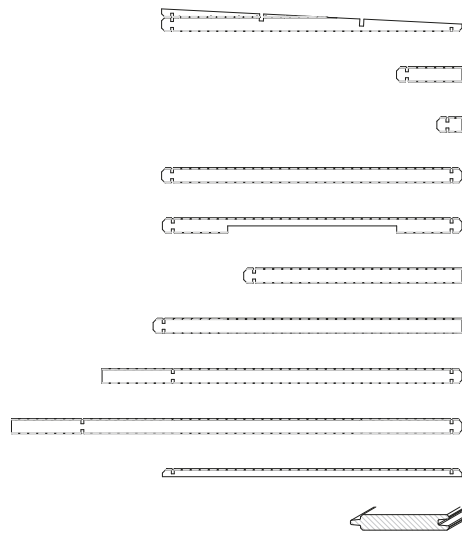

Ref.	Index	#
A	WW028x149-TPP-2LA-0-2980	3
B	WW028x149-1IF-000-0-0650	24
B1	WW028x149-1IF-000-0-0250	14
E	WW028x149-2IF-000-0-2980	40
E1	WW028x149-B1H-000-0-2980	1
G1	WW028x149-1IF-000-0-2172	8
G2	WW028x149-1IF-000-0-3072	7
G3	WW028x149-A69-000-0-3580	7
G4	WW028x149-A69-000-0-4480	8
I	WW028x079-DEM-000-0-2980	3
J	WW016x095-PLA-000-0-2950	74
<p>ALTERNATIEF : Het kan productiematig zijn dat er andere planchettes J in de verpakking zitten. De referentie is dan WW016x120-PLA-000-0-2950 => # 58stuks</p> <p>ALTERNATIVE : Il peut être lié à la production que d'autres planchettes J soient incluses dans l'emballage. La référence est alors WW016x120-PLA-000-0-2950 => # 58 pièces</p> <p>ALTERNATIVE : It may be production-related that other planchettes J are included in the package. The reference is then WW016x120-PLA-000-0-2950 => # 58 pieces</p> <p>ALTERNATIVE : Es kann produktionsbedingt sein, dass andere Planchetten J im Paket enthalten sind. Die Referenz ist dann WW016x120-PLA-000-0-2950 => # 58 Stück</p>		
K	WW040x145-PTO-1IF-0-2767	2
K1	WW040x145-PTO-000-0-3880	2
K2	WW040x070-4FA-000-0-3644	1
L	WW012x040-4FA-000-0-2950	12
M	WW016x145-VOL-086-0-3000	2
M1	WW016x145-4R8-000-0-2228	3
O	S504 Roofing 7.2m	4

Afmetingen, uiterlijk, vorm, gewicht kunnen afwijken.
Les dimensions, l'apparence, la forme, le poids peuvent différer.
Dimensions, appearance, shape, weight may differ.
Maße, Aussehen, Form, Gewicht können abweichen.

www.solid.eu/sav

Gereedschap (excl.) / Outils (excl.) / Tools (excl.) / Werkzeuge (exkl.)



Hamer
Marteau
Hammer



Schroefboormachine
Perceuse / Visseuse
Screw drill
Schraubenbohrer



Ladder
Échelle
Ladder
Leiter



Winkelhaak
Crochet carré
Square hook
Quadratischer Haken



Cirkelzaag
Scie circulaire
Circular saw
Kreissäge



Klokboor Ø 60mm
Scie cloche Ø 60mm
Hole saw Ø 60mm
Bohren Ø 60mm



Handzaag
Scie à main
Saw
Säge



Meter
Mètre
Meter
Rollenmesser



Breekmes
Couteau
Cutter
Messer



Waterpas
Niveau à bulle
Plumb rule
Wasserwaage



Decoupeerzaag
Scie sauteuse
Jigsaw
Stichsäge



Silicone + pomp
Silicone + pompe
Silicone + pump
Silikon + Pumpe

S8369

ROHAN

Afmetingen, uiterlijk, vorm, gewicht kunnen afwijken.
 Les dimensions, l'apparence, la forme, le poids peuvent différer.
 Dimensions, appearance, shape, weight may differ.
 Maße, Aussehen, Form, Gewicht können abweichen.

www.solid.eu/sav

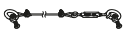
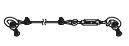
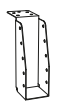
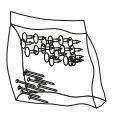
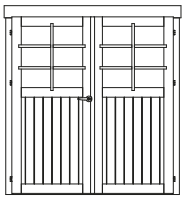

Ref.	Index	#
P	S8094C28 1 x S8094 1 x WW012x040-2R8-IF10-1757 1 x S8094ALU 2 x S8092-T 1 x S618 2 x S5242 (glass 630mm x 638mm) 1 x S80201 6 x S6201 1 x S673 (2/set)	1
R	S655 2.8 x 50 #240 3.0 x 15 #520	2
R1	S637 2.8 x 50 #100	5
R2	S625 5.0 x 70 #20	1
R3	S617 3.5 x 35 #20	1
V	WW040x055-4G4-RA28-0-2020	1
W	S6747 146	2
Y	S522	1
Y1	S521	1
Z	S6746 Ventilation-kit	1

Gereedschap (excl.) / Outils (excl.) / Tools (excl.) / Werkzeuge (exkl.)

Hamer Marteau Hammer	Schroefboormachine Perceuse / Visseuse Screw drill Schraubenbohrer	Ladder Échelle Ladder Leiter	Winkelhaak Crochet carré Square hook Quadratischer Haken	Cirkelzaag Scie circulaire Circular saw Kreissäge	Klokboor Ø 60mm Scie cloche Ø 60mm Hole saw Ø 60mm Bohren Ø 60mm
Handzaag Scie à main Saw Säge	Meter Mètre Meter Rollenmesser	Breekmes Couteau Cutter Messer	Waterpas Niveau à bulle Plumb rule Wasserwaage	Decoupeerzaag Scie sauteuse Jigsaw Stichsäge	Silicone + pomp Silicone + pompe Silicone + pump Silikon + Pumpe

- I = 3
- B = 2
- B1 = 1
- E = 1
- G1 = 1
- G4 = 1

1

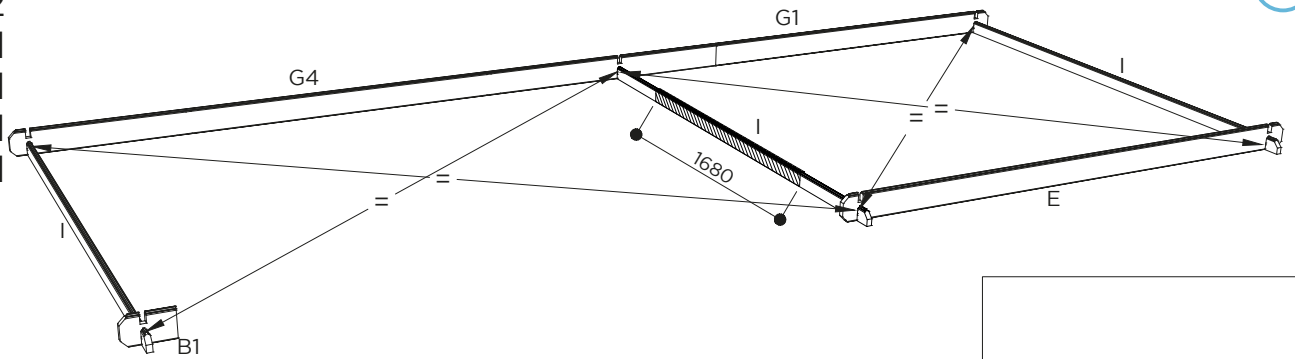

Mogelijkheid
Possibilité
Possibility
Möglichkeit

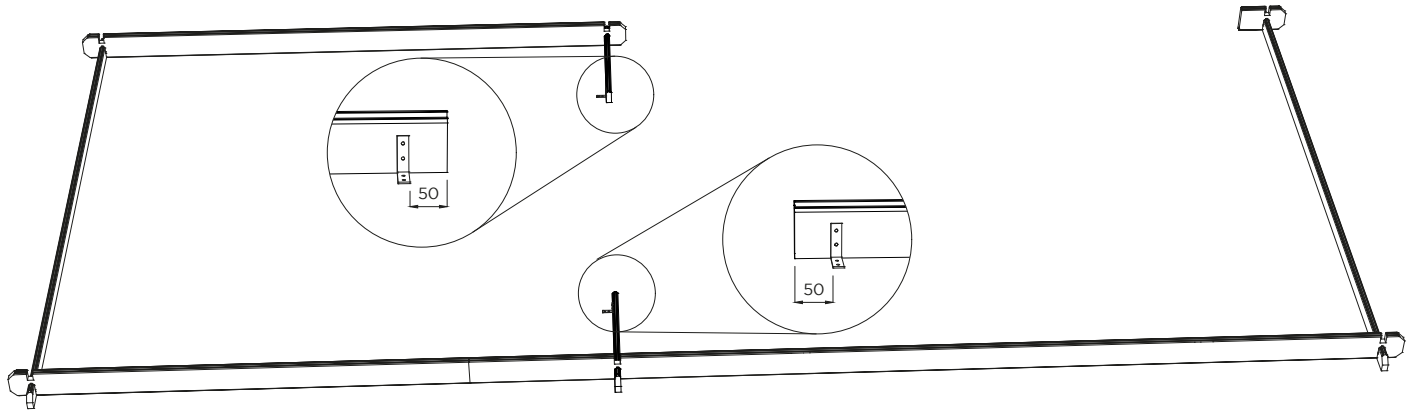
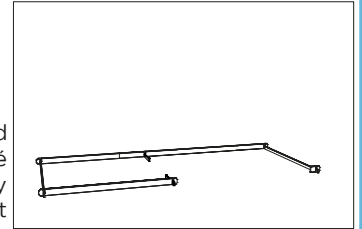

3.0 x 30 # 8

- B = 10
- B1 = 6
- E = 18
- G1 = 3
- G2 = 3
- G3 = 3
- G4 = 3

2

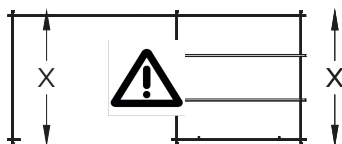
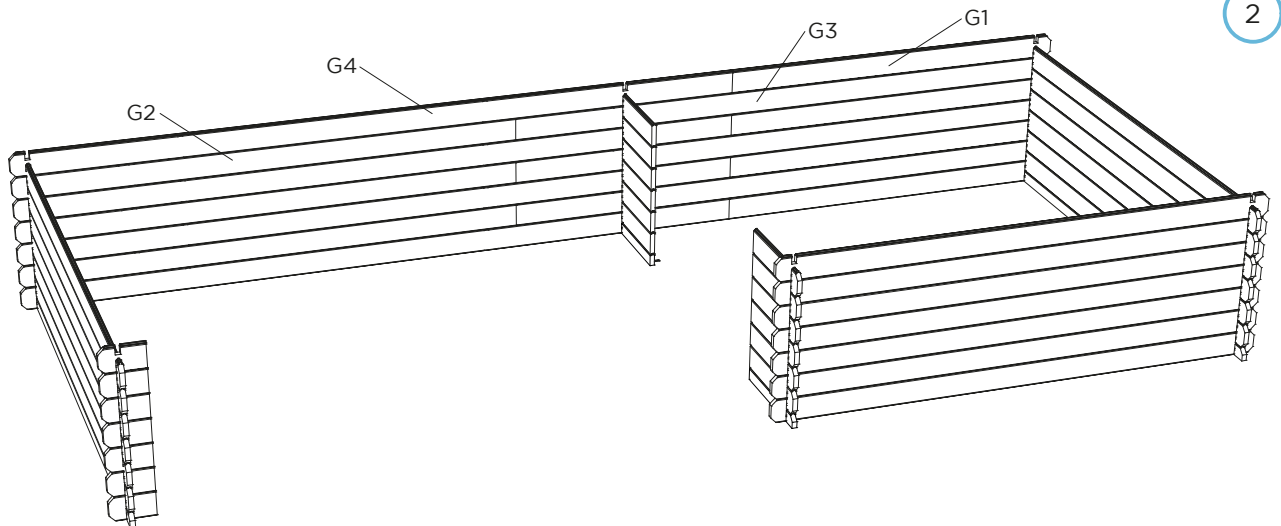

Mogelijkheid
Possibilité
Possibility
Möglichkeit

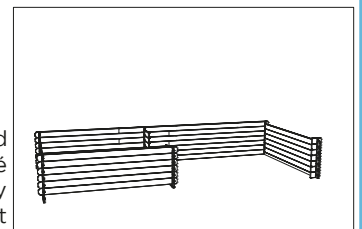

B = 12
 B1 = 6
 E = 21
 E1 = 1
 G1 = 3
 G2 = 3
 G3 = 3
 G4 = 3

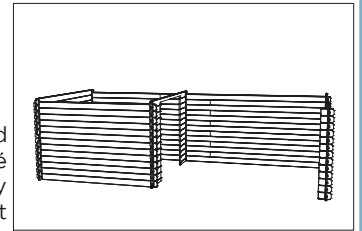
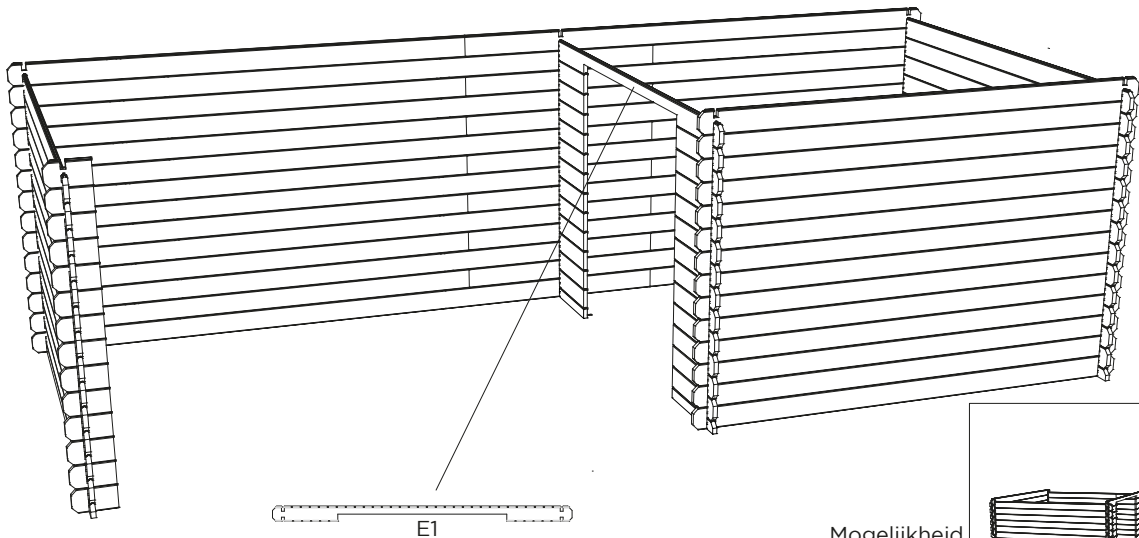

Mogelijkheid
 Possibilité
 Possibility
 Möglichkeit



(NL) INFORMATIE :

Het is niet abnormaal dat kleine openingen te zien zijn bij de montage, zowel boven de deur als bij de dakopbouw. Deze zullen na het natuurlijk drogen van het product verdwijnen, hou er evenwel rekening mee dat dit enkele weken kan duren.

(FR) INFORMATION :

Il n'est pas anormal qu'il y ait des ouvertures à voir lors du montage tant au-dessus de la porte et les fenêtres qu'en montant le toit. Ceux-ci disparaîtront après le séchage naturel du produit. Tenez cependant compte que cela peut durer quelques semaines.

(GB) INFORMATION :

It is not unusual that small openings are visible during the assembly, both above the door and in the roof. These will disappear after the natural drying of the product, keep in mind, however, that this may take several weeks.

(D) INFORMATION :

Es ist nicht abnormal, dass beim Aufbau, sowohl oberhalb der Tür als auch beim Dachaufbau kleine Öffnungen zu sehen sind. Nach der natürlichen Trocknung des Produktes werden diese verschwinden. Berücksichtigen Sie aber, dass dies einige Wochen in Anspruch nehmen kann.

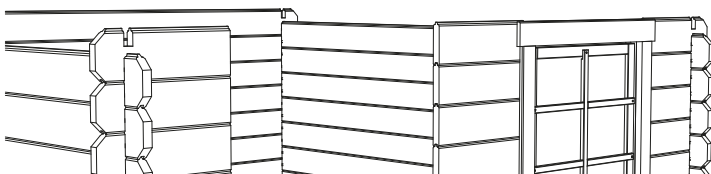
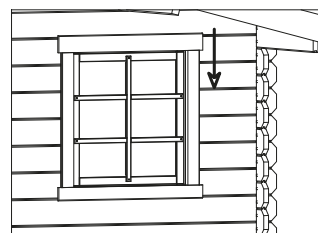
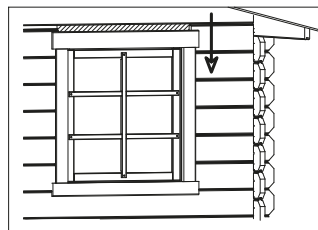
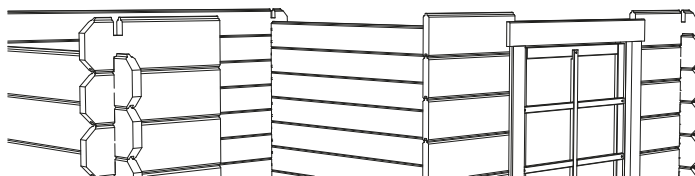

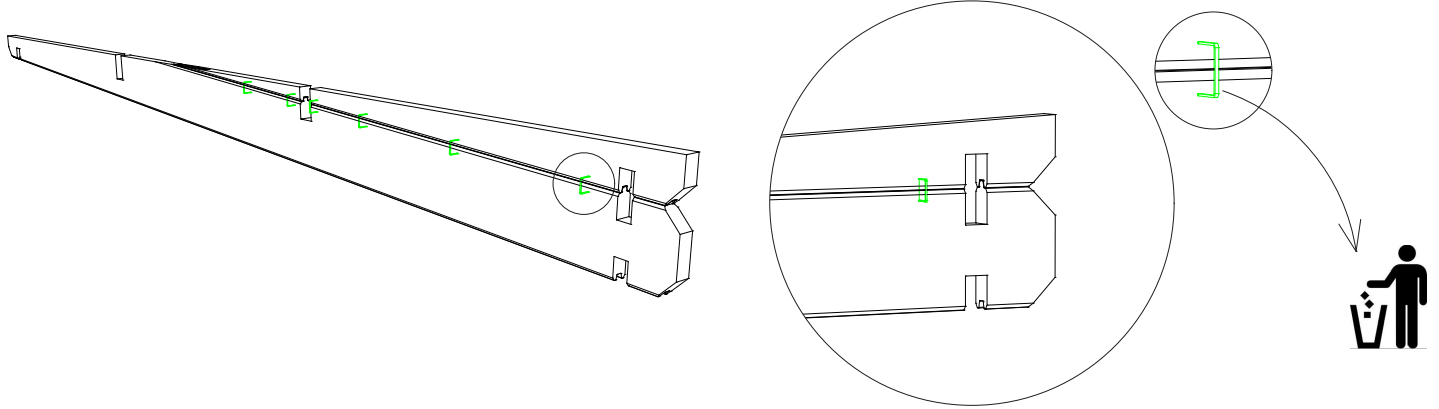

G1 = 1
 G4 = 1
 K2 = 1
 V = 1

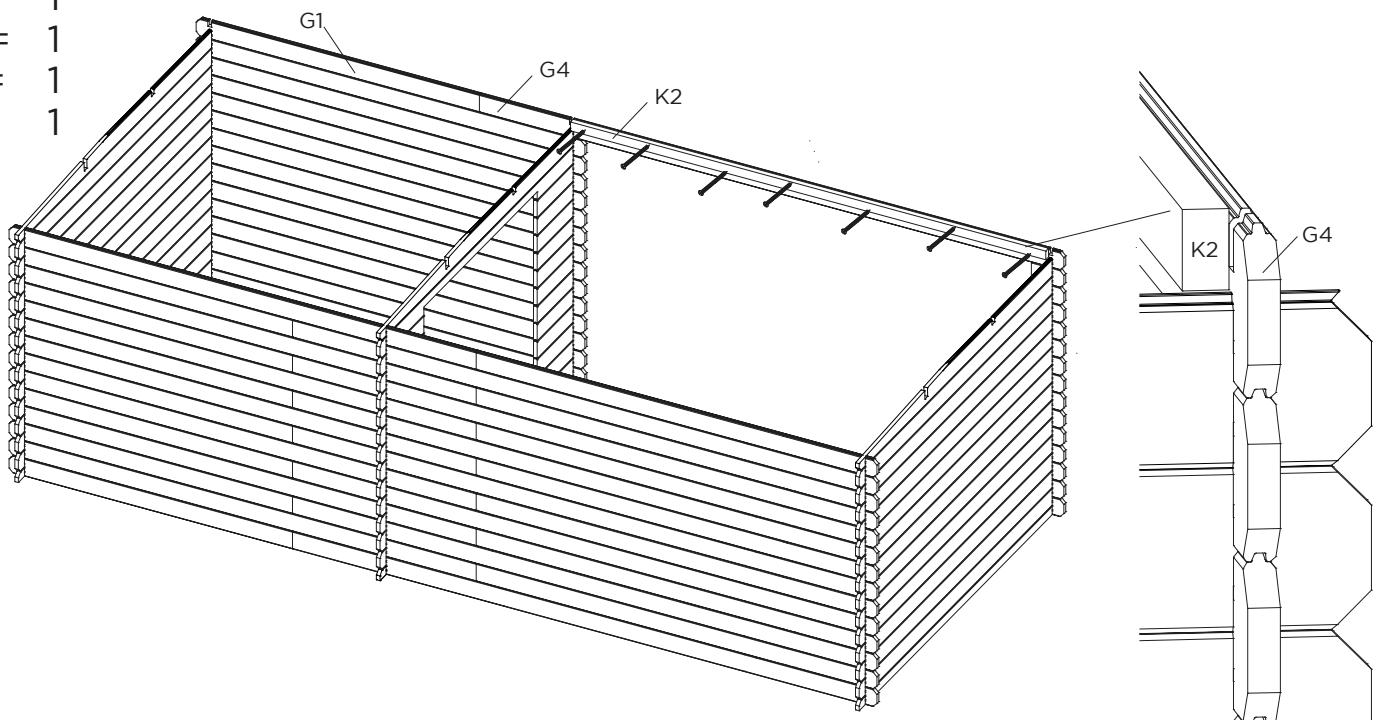

(NL) INFORMATIE :

Laat het natuurlijke krimpen en uitzetten van het hout toe in functie van de seizoenen. Bevestigingsbouten niet inbegrepen. Op de 3 plaatsen de bouten te voorzien !!

(FR) INFORMATION :

Permet au bois de rétrécir et de se dilater naturellement selon les saisons. Boulons de montage non inclus. Prévoir les boulons aux 3 endroits !!

(GB) INFORMATION :

Allows the wood to shrink and expand naturally according to the seasons. Mounting bolts not included. Provide the bolts in the 3 places !!

(D) INFORMATION :

Lässt das Holz je nach Jahreszeit auf natürliche Weise schrumpfen und sich ausdehnen. Befestigungsschrauben nicht enthalten. Stellen Sie die Schrauben an den 3 Stellen bereit !!

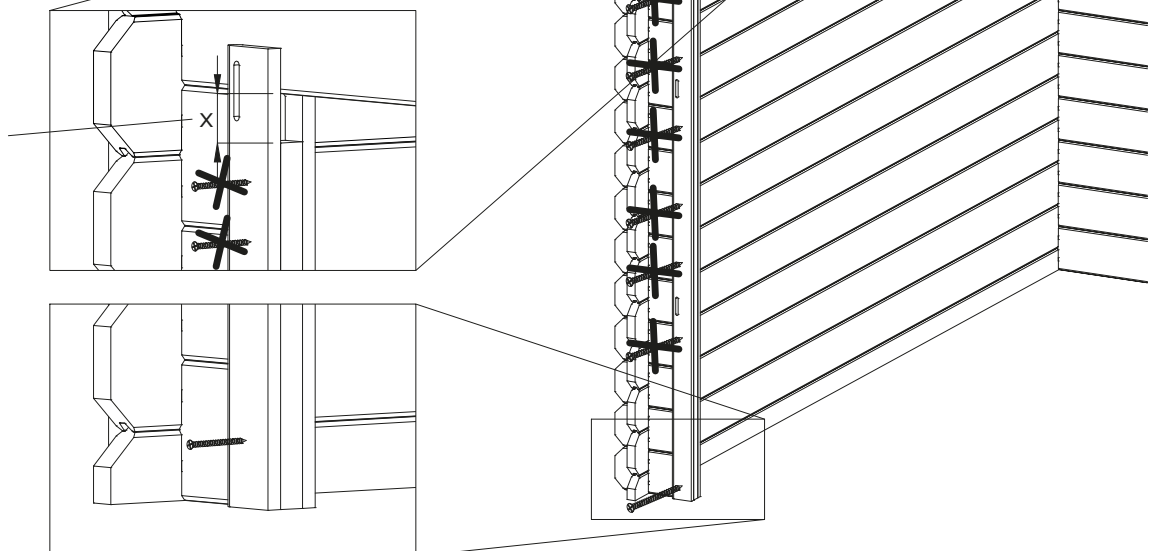

A = 3

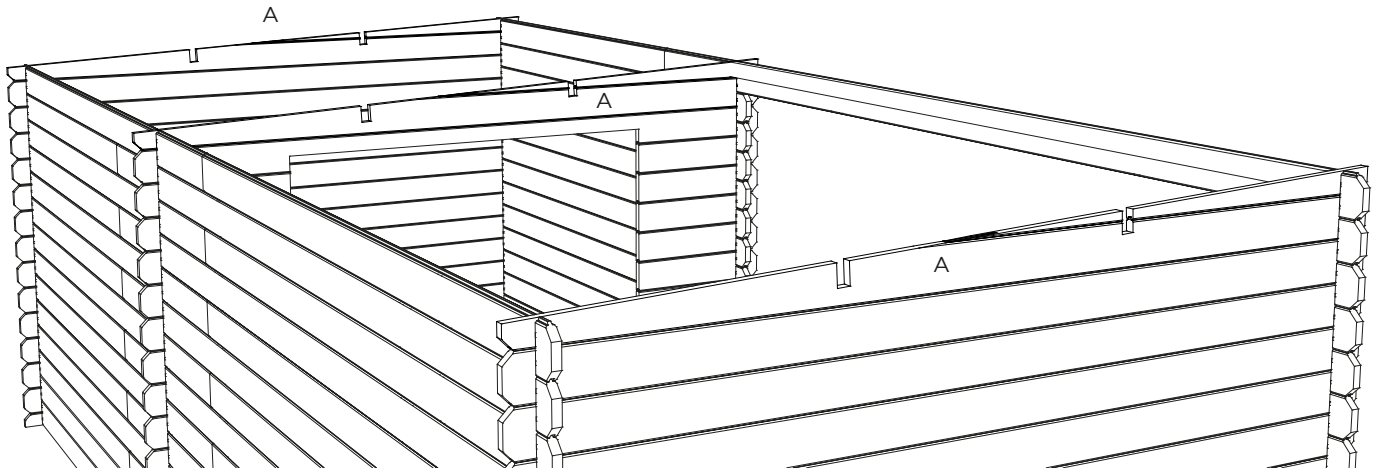

Aanbeveling / Conseil / Recommendation / Empfehlung

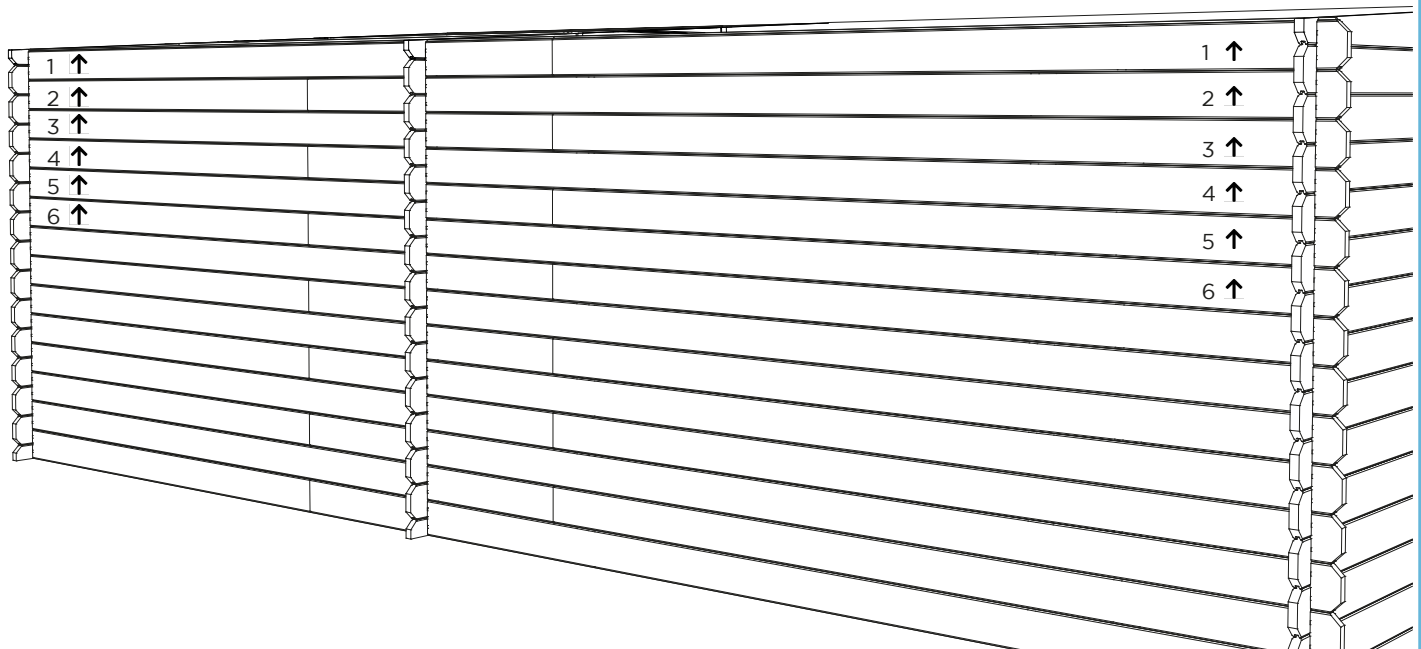
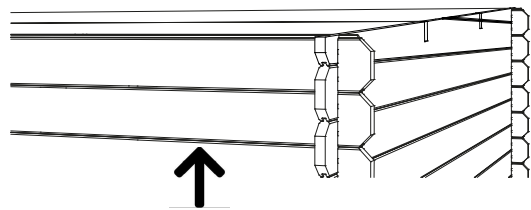
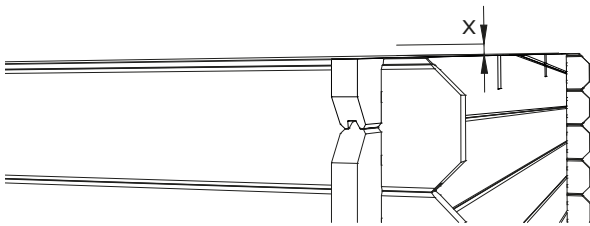







Verplicht / Obligatoire / Required / Verpflichtet

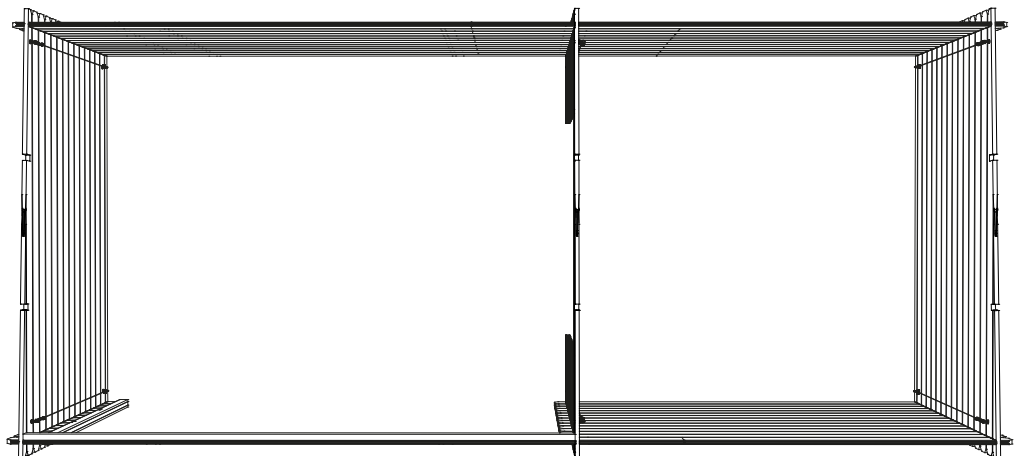
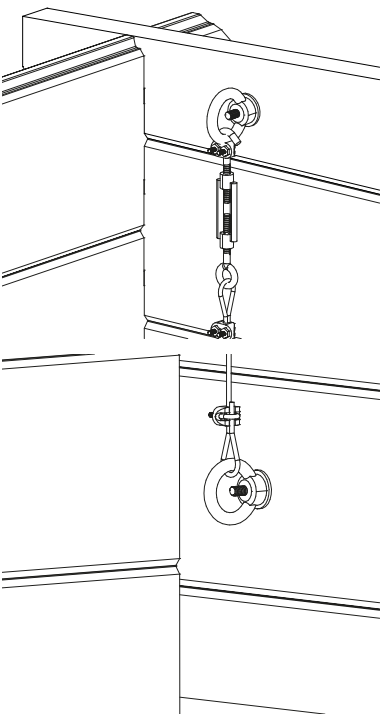
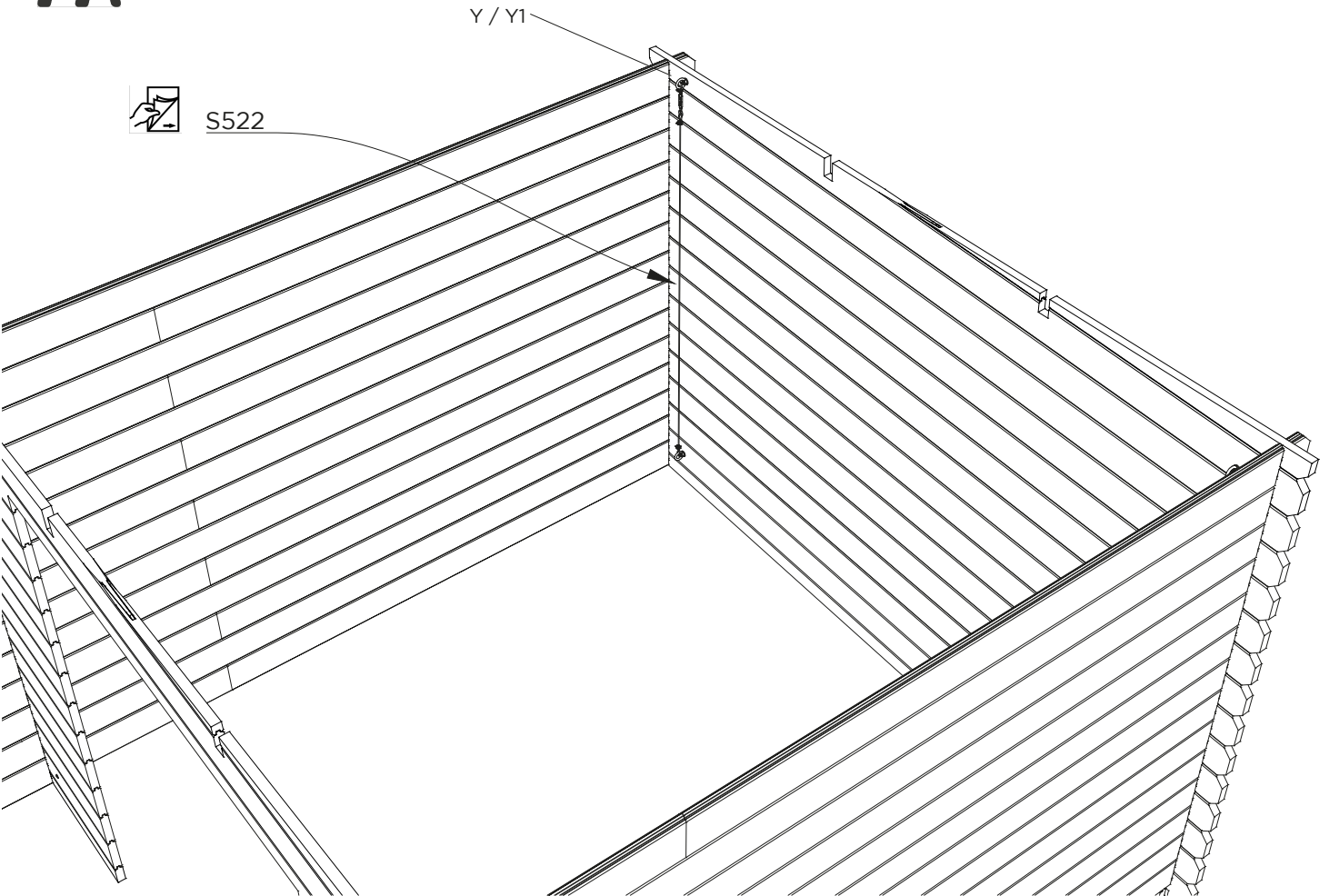

Y = 1
Y1 = 1



- K = 2
- K1 = 2
- W = 2
-  2.8 x 50 # 8
-  3.0 x 35 # 8
-  5.0 x 70 # 8

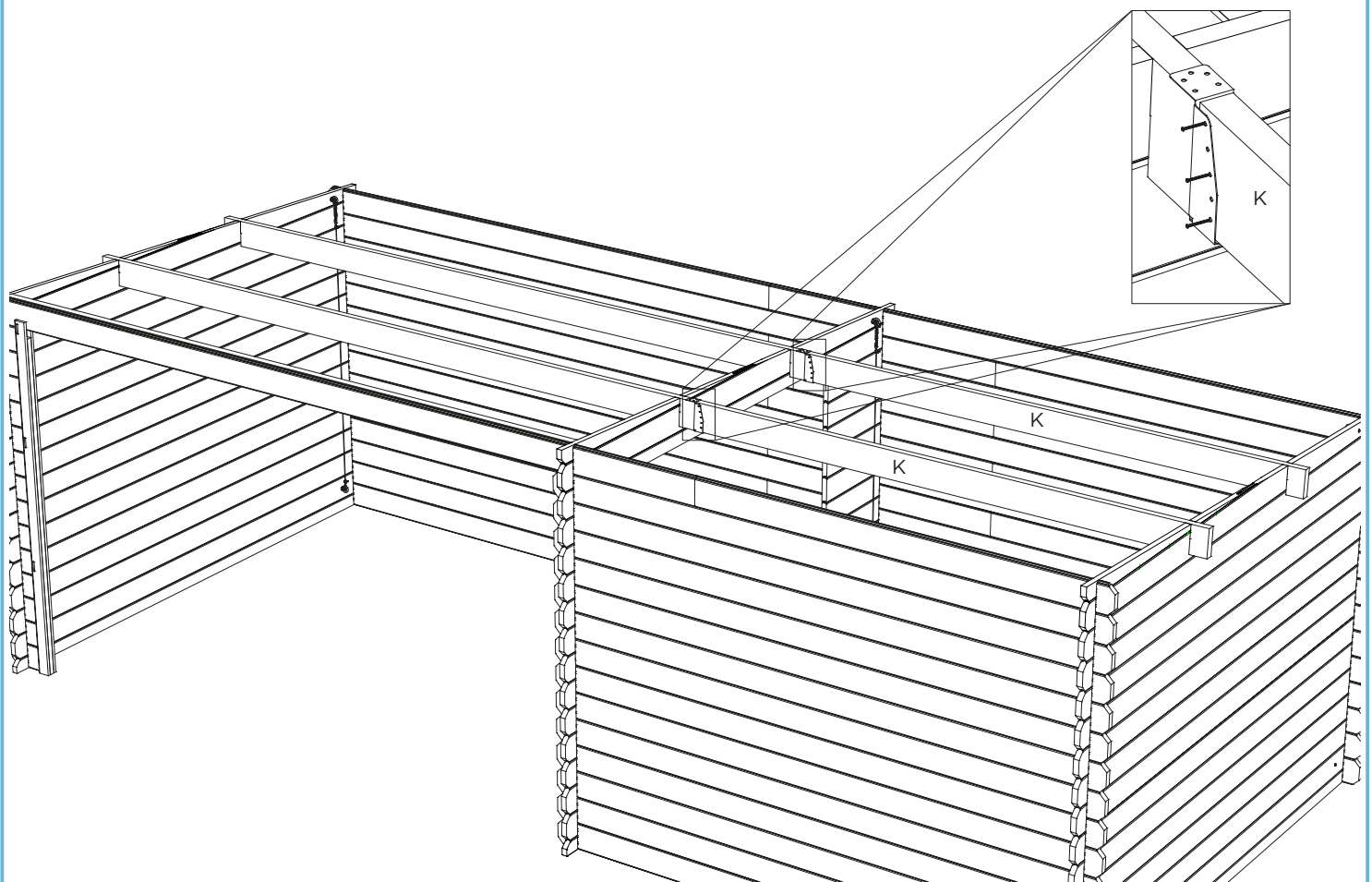
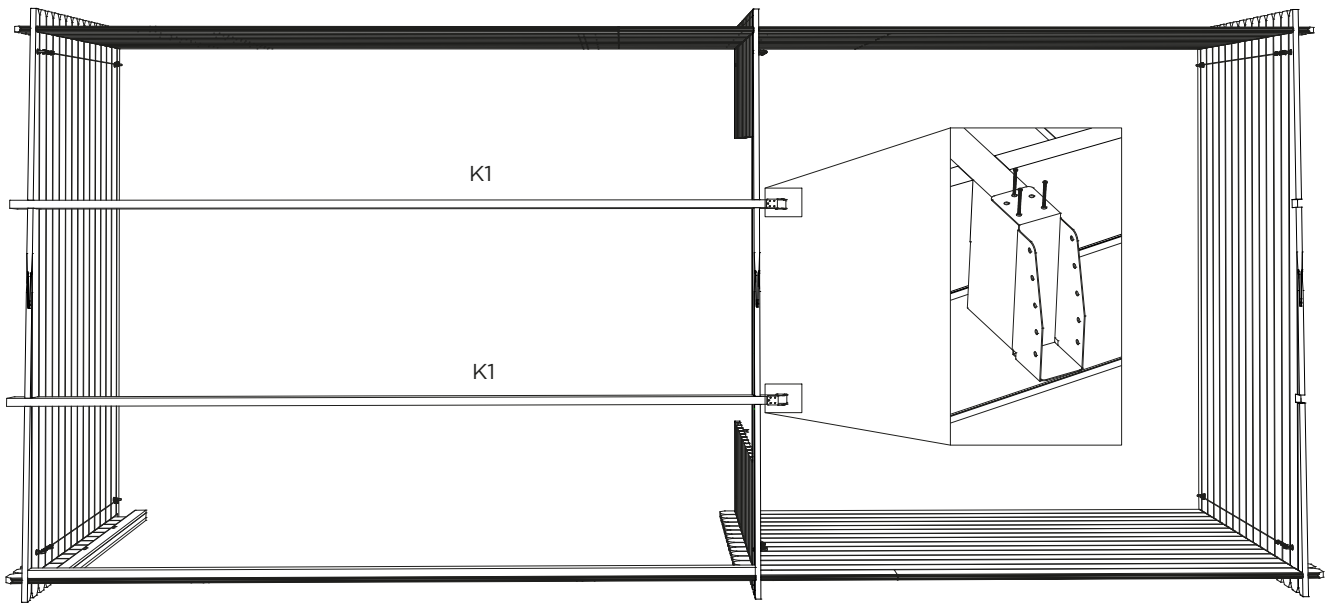

J = 74 of/ou/or/oder 58
2.8 x 50 # 592

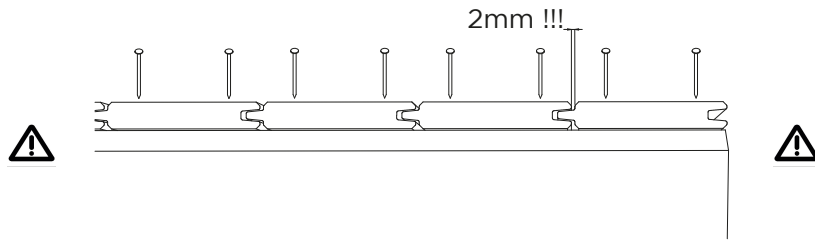
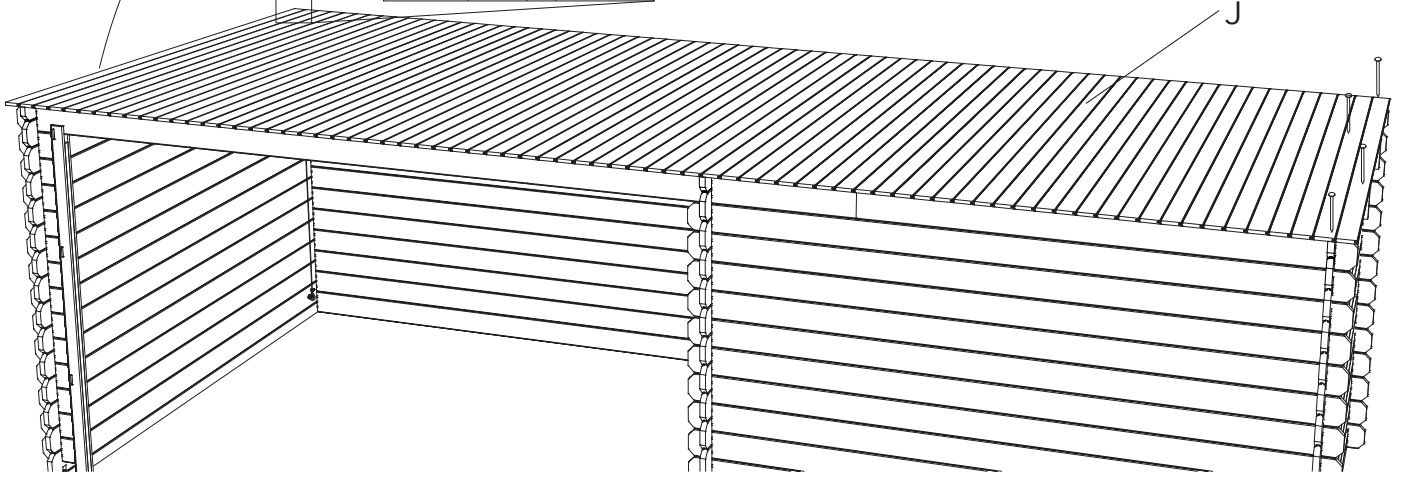
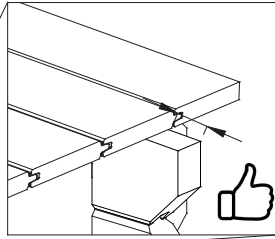
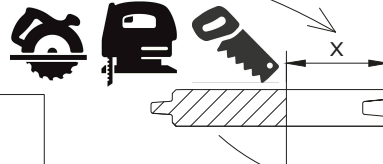

O = 4
3.0 x 15 # 20 /m²

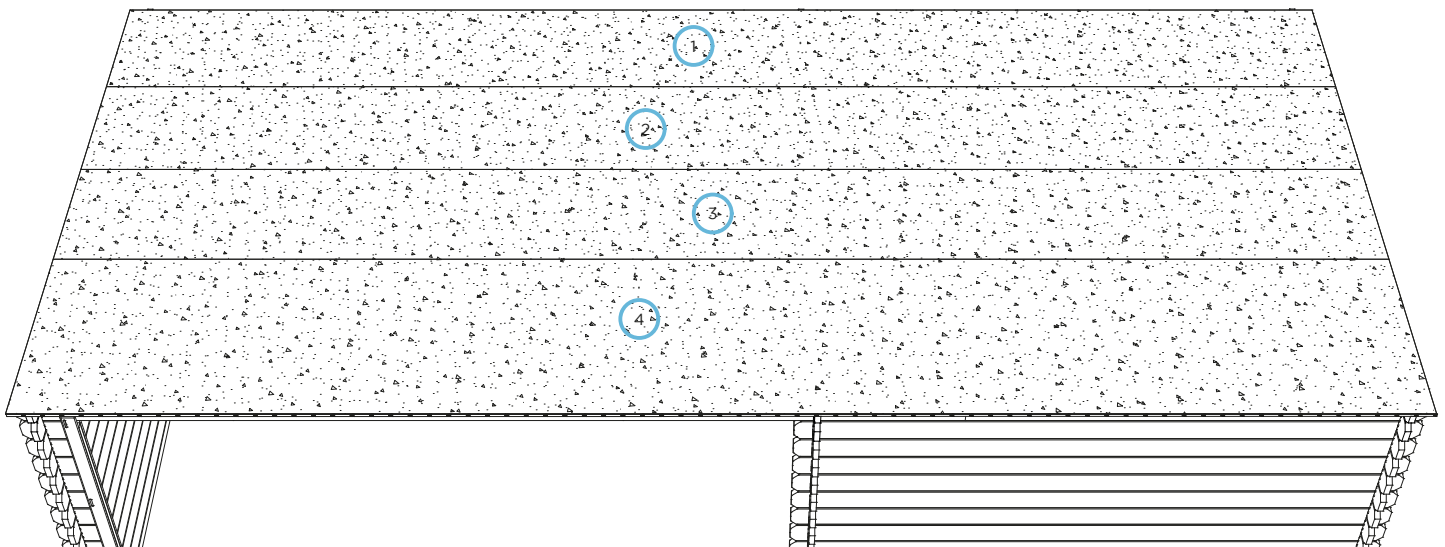
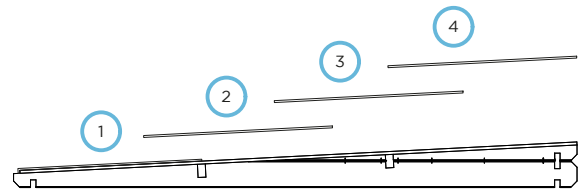
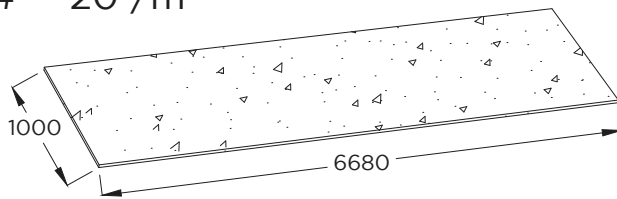

L = 12
2.8 x 50 # 56

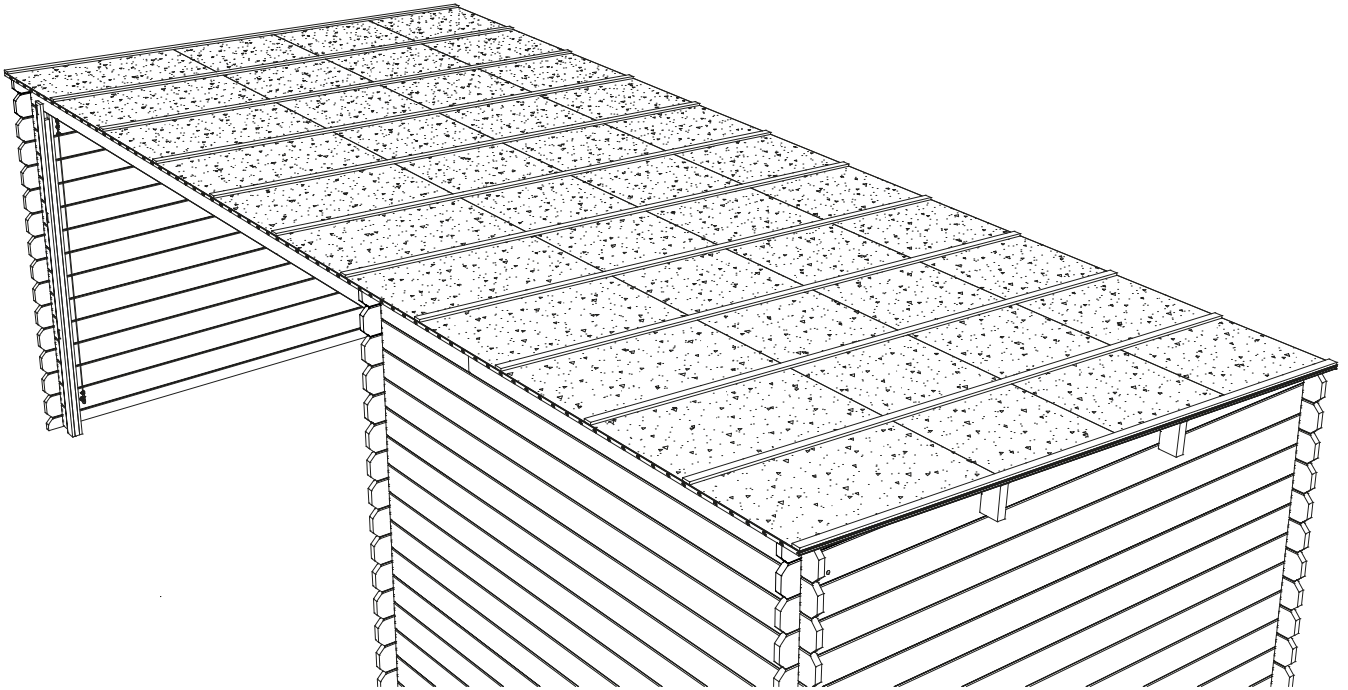

M = 2
M1 = 3
2.8 x 50 # 20

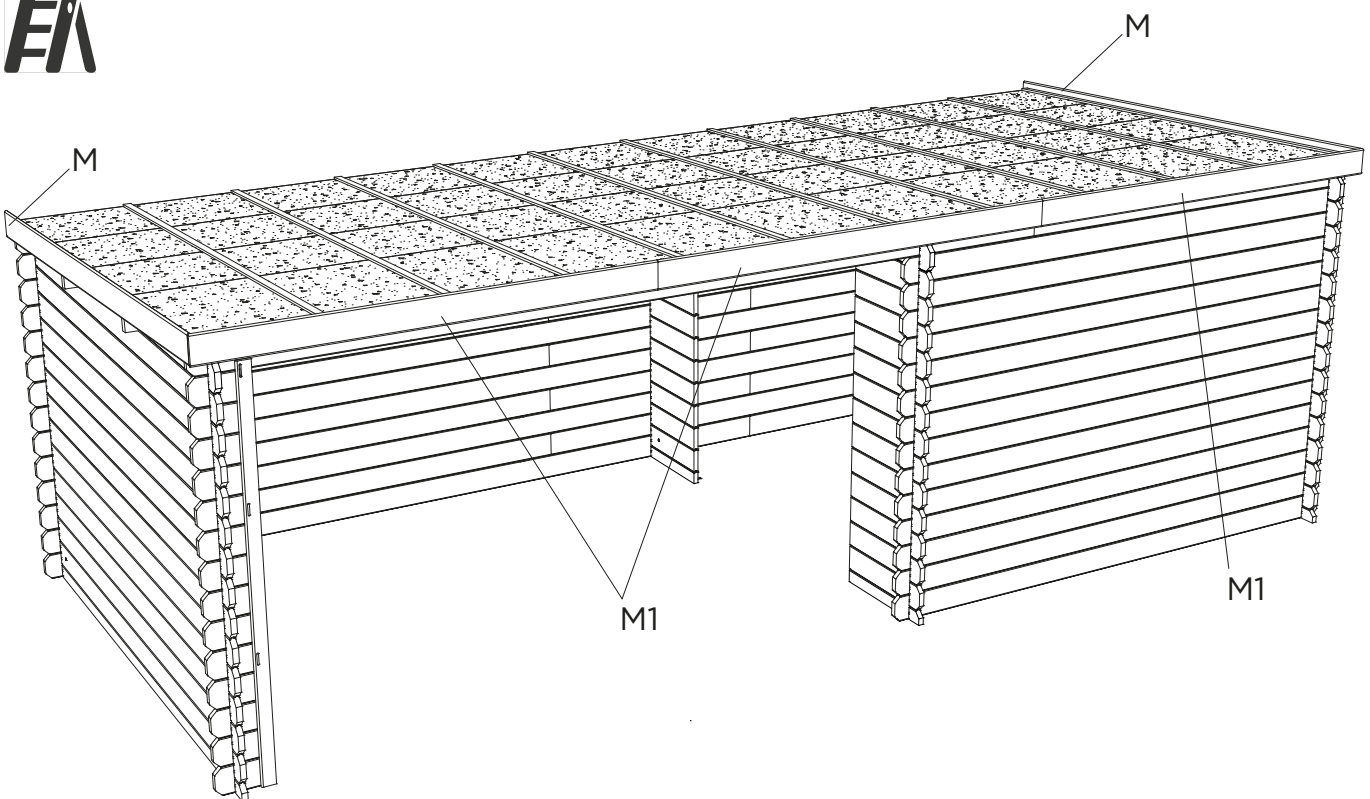

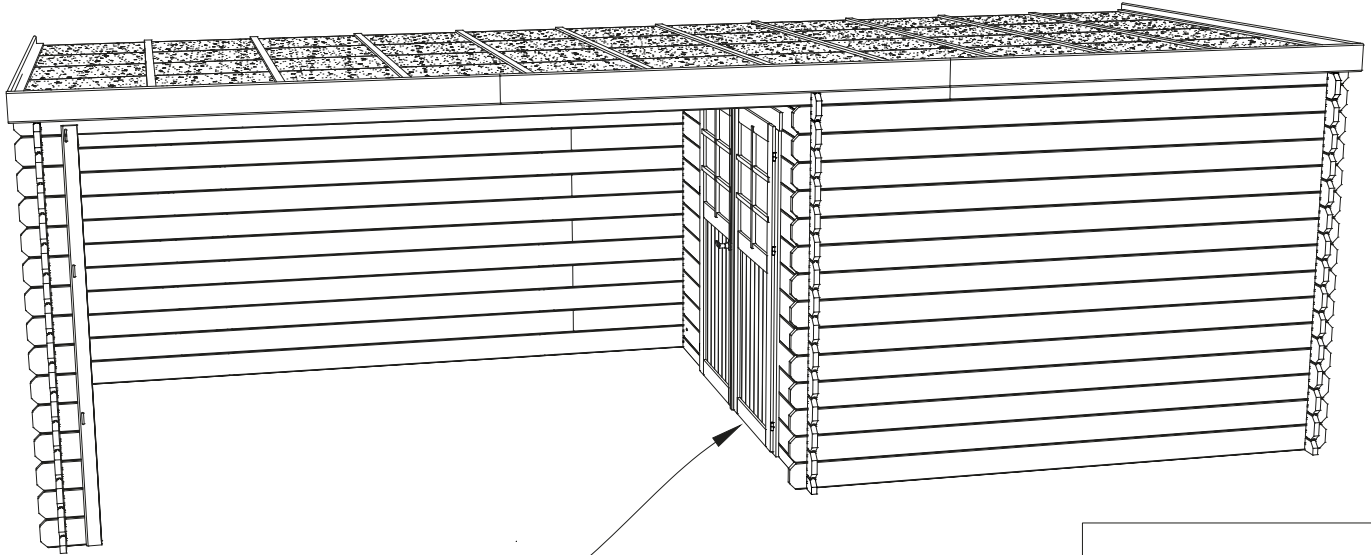

S8094C28

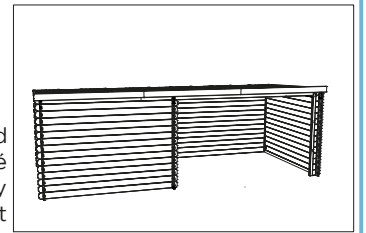

Mogelijkheid
Possibilité
Possibility
Möglichkeit

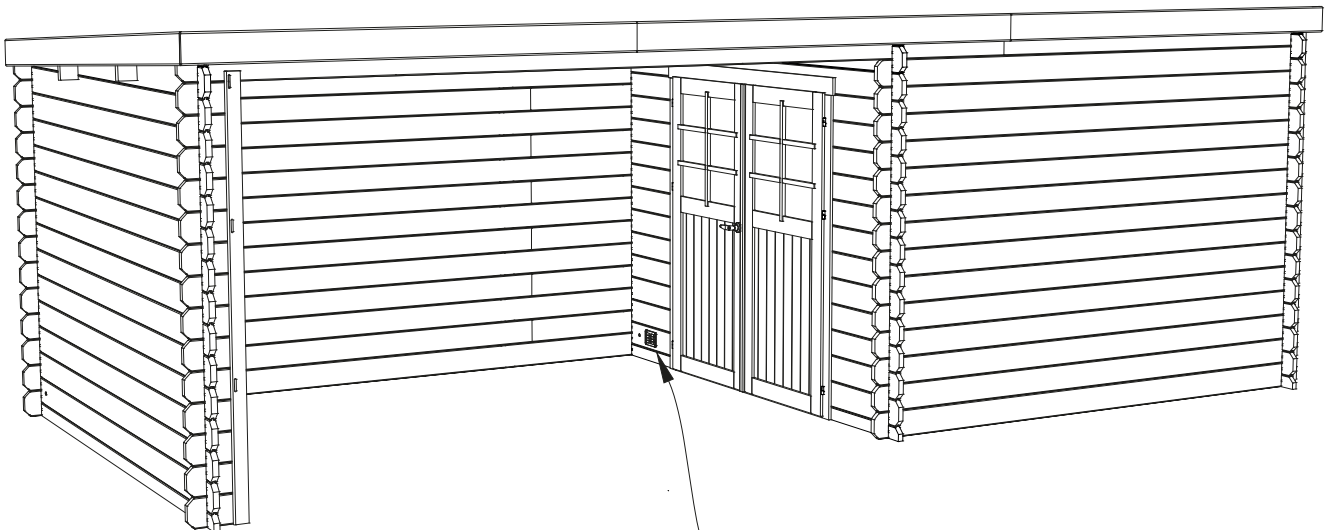

S6746 Ventilation-kit



Aanbeveling / Conseil / Recommendation / Empfehlung

NL

F

GB

D

Het kan voorvallen dat er smalle latjes op de deur gemonteerd zijn. Deze dienen ter bescherming/transport/verpakking. Gelieve deze latjes en de nietjes te verwijderen.

Il peut arriver que des lamelles étroites soient montées sur la porte. Ceux-ci servent de protection / transport / emballage. Veuillez retirer ces lattes et ces agrafes.

It may happen that narrow slats are mounted on the door. These serve for protection / transport / packaging. Please remove these slats and staples.

Es kann vorkommen, dass schmale Lamellen an der Tür montiert sind. Diese dienen zum Schutz / Transport / Verpackung. Bitte entfernen Sie diese Lamellen und Heftklammern.

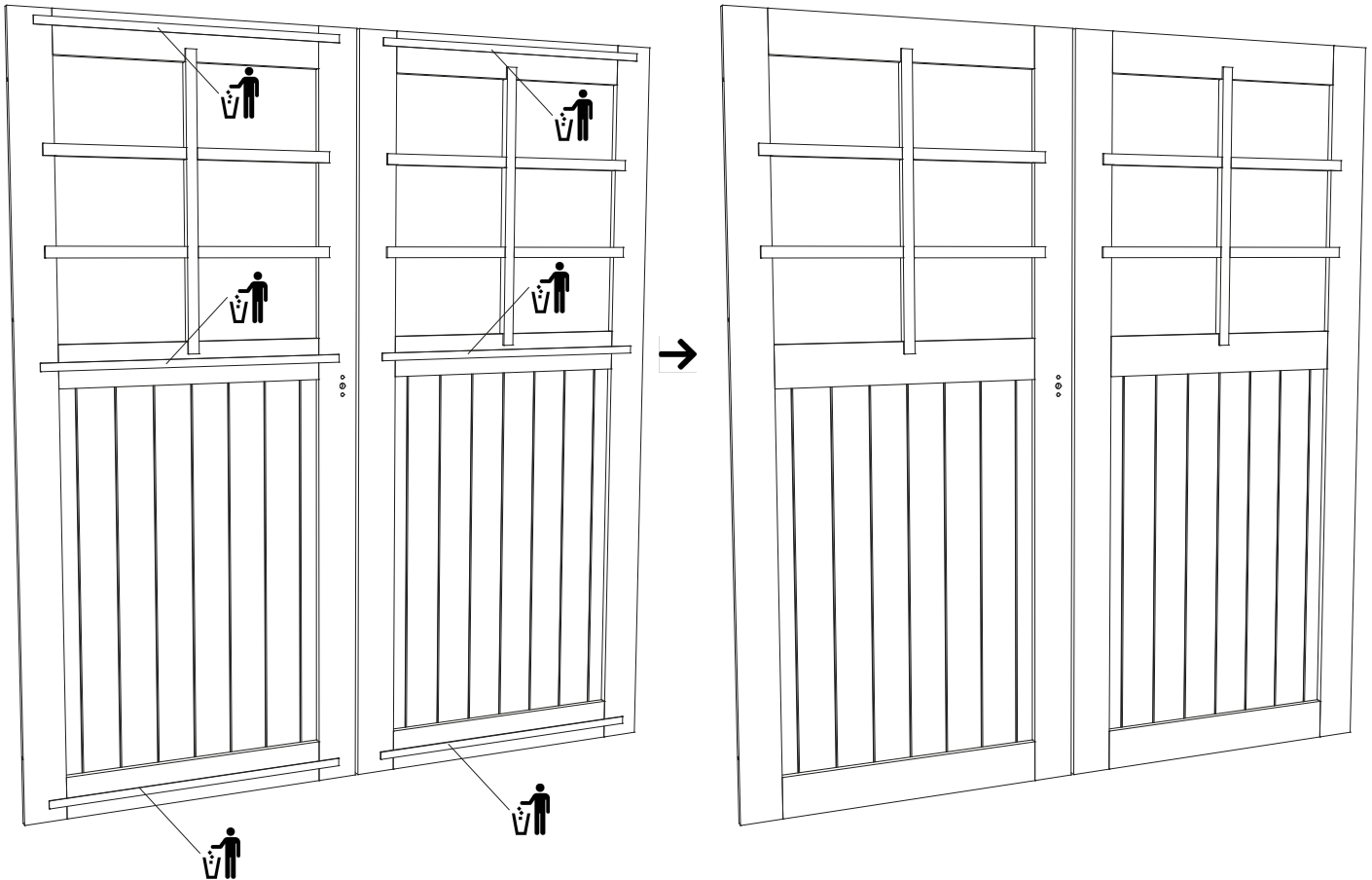

Hamer
Marteau
Hammer



Schroefboormachine
Perceuse / Visseuse
Screw drill
Schraubenbohrer



Ladder
Échelle
Ladder
Leiter



Winkelhaak
Crochet carré
Square hook
Quadratischer Haken



Cirkelzaag
Scie circulaire
Circular saw
Kreissäge



Klokboor Ø 60mm
Scie cloche Ø 60mm
Hole saw Ø 60mm
Bohren Ø 60mm



Handzaag
Scie à main
Saw
Säge



Meter
Mètre
Meter
Rollenmesser



Breekmes
Couteau
Cutter
Messer



Waterpas
Niveau à bulle
Plumb rule
Wasserwaage



Decoupeerzaag
Scie sauteuse
Jigsaw
Stichsäge



Silicone + pomp
Silicone + pompe
Silicone + pump
Silikon + Pumpe

S8094C28

Voorwand / Paroi avant / Front wall / Vorderwand

A

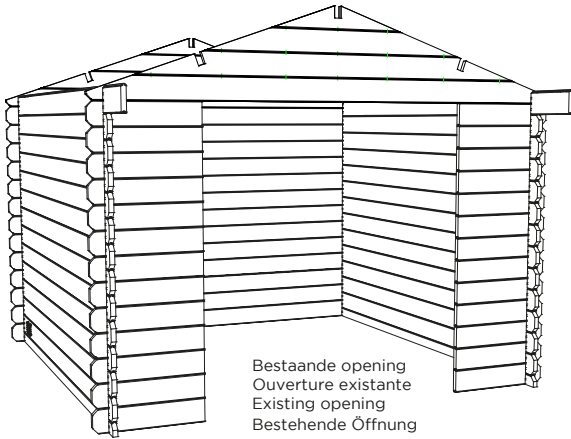

Model tuinhuis kan afwijken.
Modèle de l'abri de jardin peut différer.
Garden house model may differ.
Gartenhausmodell kann abweichen.



Ga verder met de handleiding van **S8094C28**.

Continuer avec le manuel de **S8094C28**.

Continue with the manual from **S8094C28**.

Fahren Sie mit dem Handbuch von fort **S8094C28**.

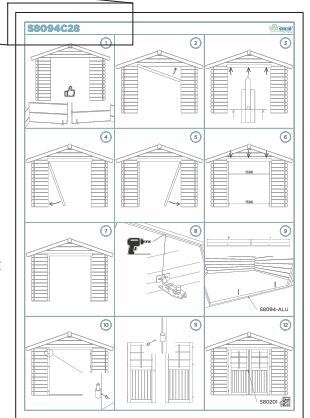

Voor-of achterwand / Paroi avant ou arrière / Front or back wall / Vorder-oder Rückwand

B

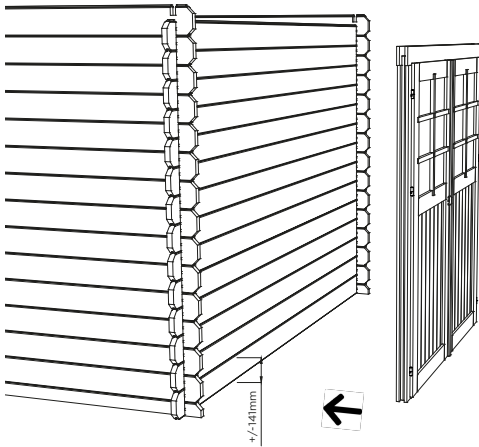

Ga verder met de handleiding van **Voor-of achterwand**.

Continuer avec le manuel de **Paroi avant ou arrière**.

Continue with the manual from **Front or back wall**.

Fahren Sie mit dem Handbuch von fort **Vorder-oder Rückwand**.

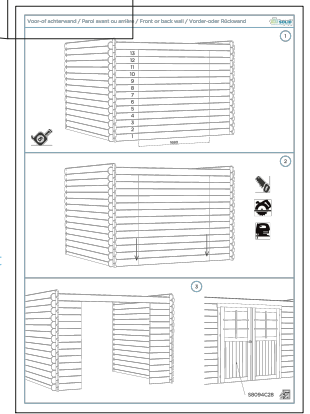

Zijwand / Paroi Coté / Sidewall / Seitenwand

C

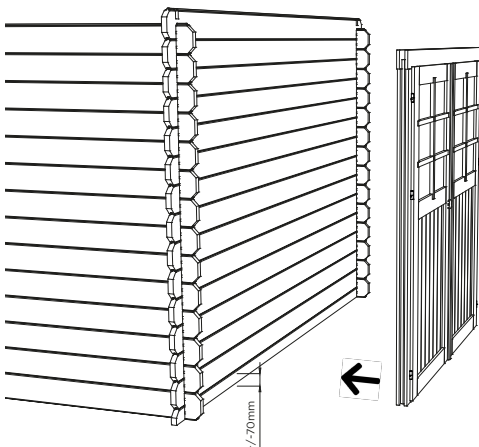

Ga verder met de handleiding van **Zijwand**.

Continuer avec le manuel de **Paroi coté**.

Continue with the manual from **Sidewall**.

Fahren Sie mit dem Handbuch von fort **Seitenwand**.

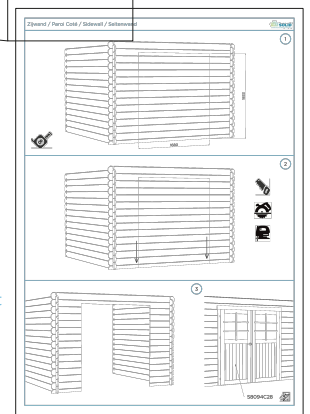

Hamer
Marteau
Hammer



Schroefboormachine
Perceuse / Visseuse
Screw drill
Schraubenbohrer



Ladder
Échelle
Ladder
Leiter



Winkelhaak
Crochet carré
Square hook
Quadratischer Haken



Cirkelzaag
Scie circulaire
Circular saw
Kreissäge



Klokböor Ø 60mm
Scie cloche Ø 60mm
Hole saw Ø 60mm
Bohren Ø 60mm



Handzaag
Scie à main
Saw
Säge



Meter
Mètre
Meter
Rollenmesser



Breekmes
Couteau
Cutter
Messer



Waterpas
Niveau à bulle
Plumb rule
Wasserwaage



Decoupeerzaag
Scie sauteuse
Jigsaw
Stichsäge



Silicone + pomp
Silicone + pompe
Silicone + pump
Silikon + Pumpe

1

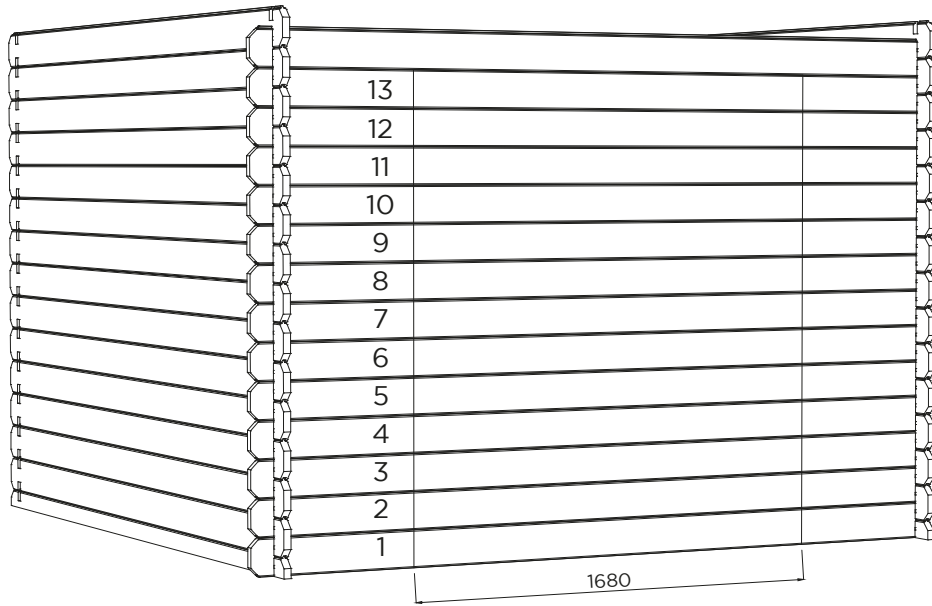

2

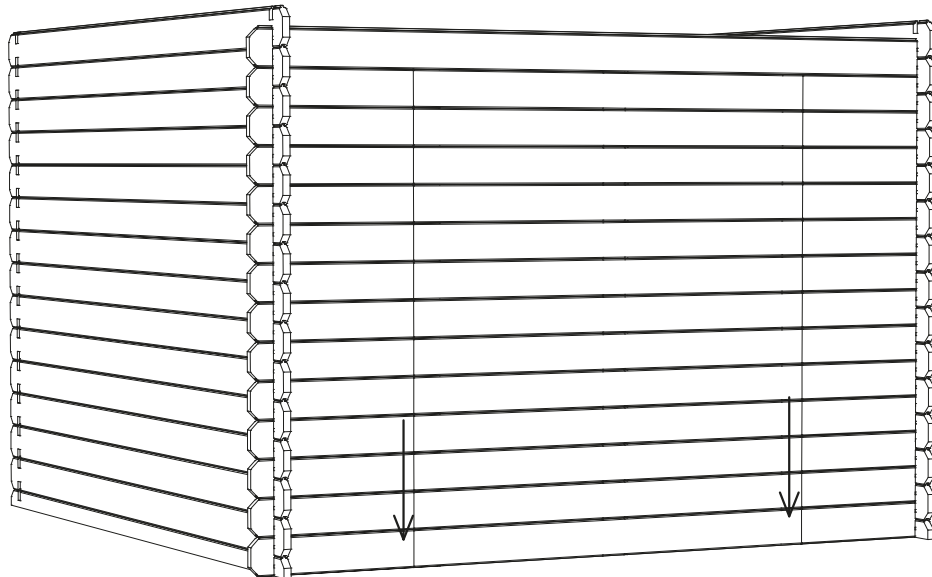

3

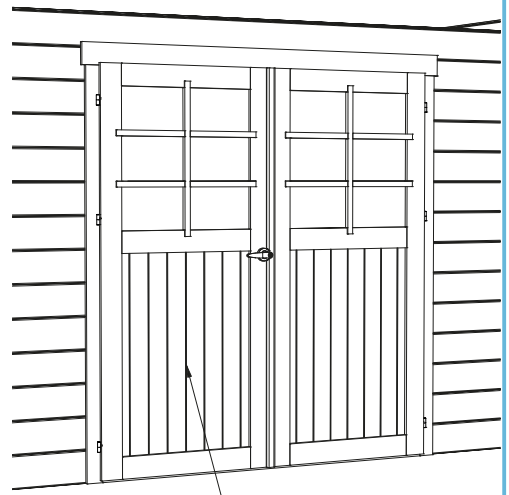
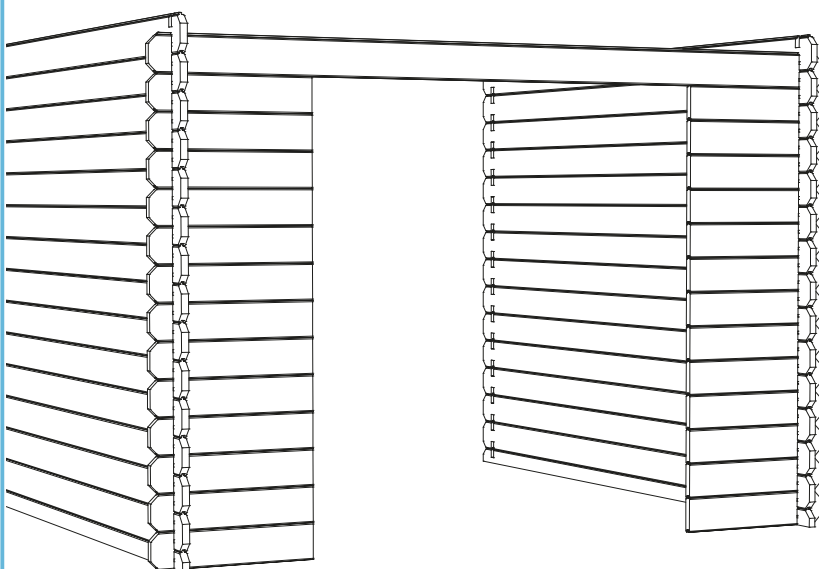

S8094C28



1

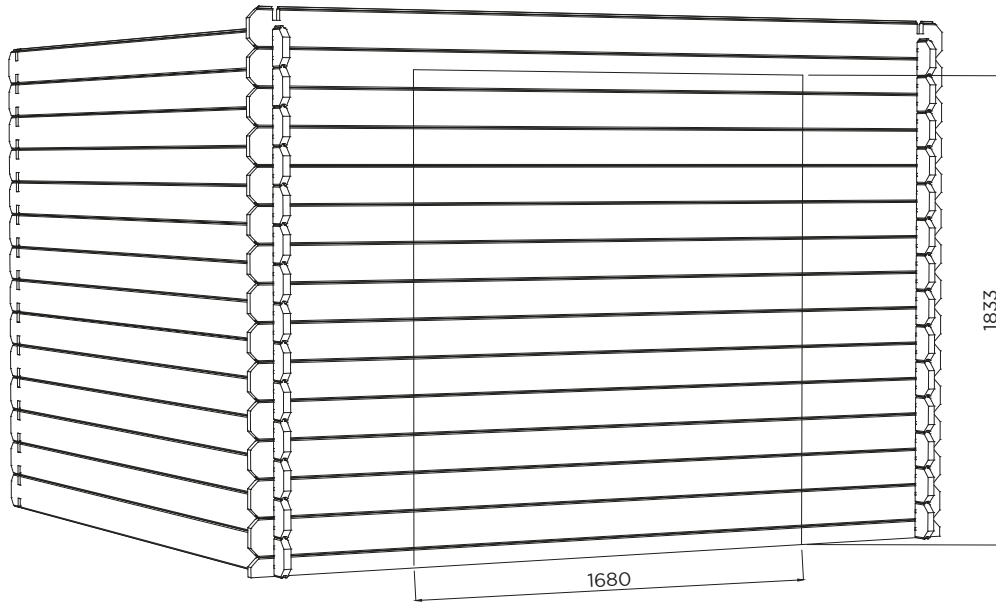

2

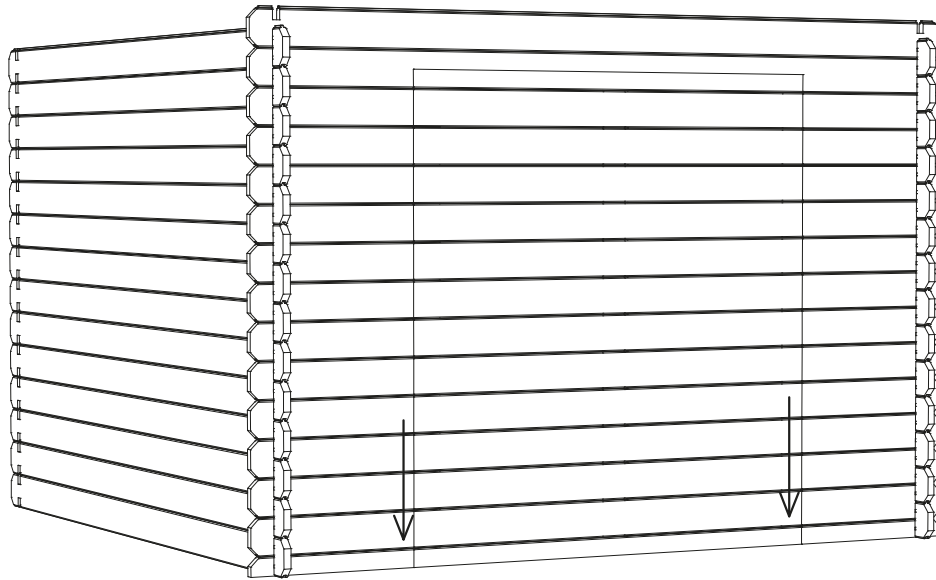

3

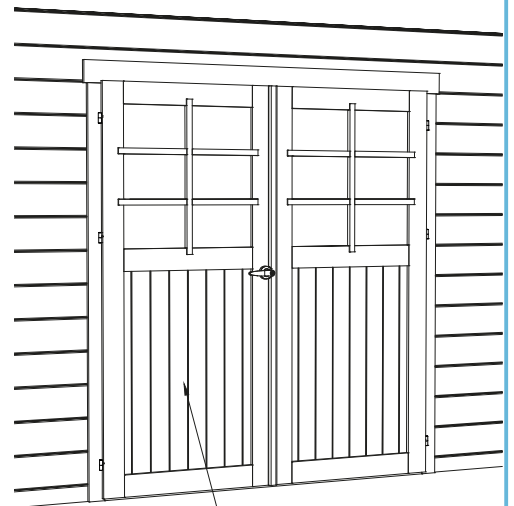
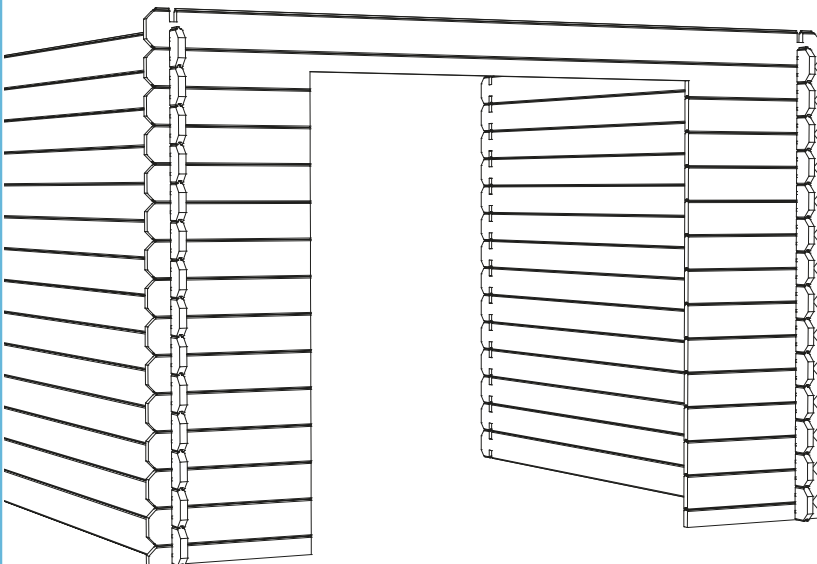

S8094C28



